

 **e904**

Bedienungsanleitung
Instructions for use
Notice d'emploi
Istruzioni per l'uso
Instrucciones para el uso
Gebruiksaanwijzing



evolution

Bedienungsanleitung.....	3
Instructions for use	9
Notice d'emploi	15
Istruzioni per l'uso.....	21
Instrucciones para el uso.....	27
Gebruiksaanwijzing.....	33

DEUTSCH

Hochwertiges dynamisches Mikrofon mit Nierencharakteristik.

Durch seine kurze Bauweise ist es besonders gut für den Einsatz am Schlagzeug (Tom und Snare) geeignet. Es lässt sich auch bei beengten Platzverhältnissen (z.B. unter Becken) gut platzieren und mit der mitgelieferten Mikrofonhalterung (MZH 604) einfach und genau am Instrumentenrand befestigen.

Auch zur Abnahme von Gitarrenverstärkern, Percussion-Instrumenten sowie Blech- und Holzblasinstrumenten ist es gut einsetzbar.

Das Metallgehäuse schützt das Mikrofon wirkungsvoll im rauen Roadeinsatz.

Der um 45° gedrehte XLR-Stecker erlaubt eine platzsparende Anordnung des Mikrofons bei abgewinkelten Steckern.

Merkmale

- enorm lebendiger, druckvoller Sound bei Drums und Percussions
- hervorragende Formbarkeit des Sounds für alle Stilrichtungen
- extrem robust für den rauen Touralltag
- Brummkompensationsspule gegen Einstreuungen
- vergoldeter XLR-Stecker (45° gedreht)

Lieferumfang

Mikrofon 904

Tasche

Mikrofonhalterung MZH 604

Bedienungsanleitung

Garantiekarte

Anschlussbelegung XLR-3

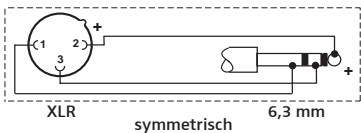
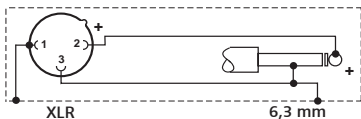
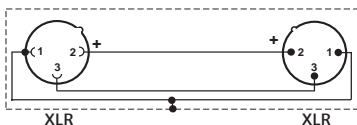
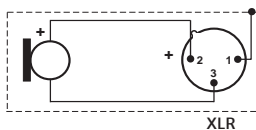

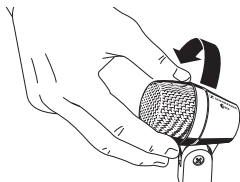

Einsprachekorb abdrehen



Mikrofon platzieren

Trommeln

Positionierung	Klangresultat	Kommentar
	wenig Grundton, viel Obertöne	Positionierung an der Trommel: 3 - 5 cm über dem Fell, Verhältnis Grundton zu Obertönen lässt sich mit dem Winkel einstellen. Die ausgewogensten Ergebnisse erreicht man unter einem 30 - 60° Winkel.
	viel Grundton, wenig Obertöne	
		Verwendung eines zweiten e904 zur Abnahme des Resonanzfells und der Snares. Bei einem Mikrofon evtl. Phasendrehung aktivieren.

Um Störungen durch Übersprechen von benachbarten Schallquellen zu vermeiden, versuchen Sie, das Mikrofon so zu positionieren, dass die Störschallquelle im Winkelbereich der größten Auslöschung des Mikrofons liegt (ca. 180°).

Polardiagramm

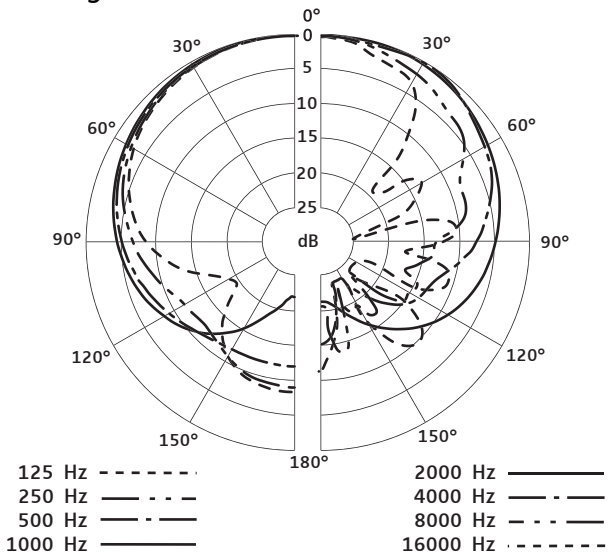

Frequenzgang

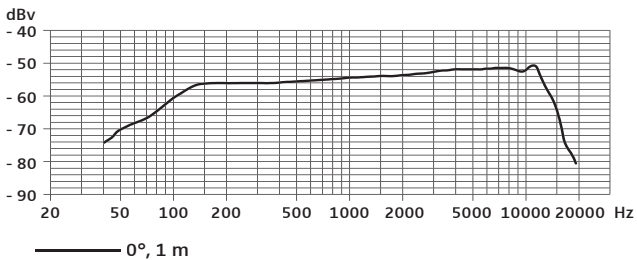

Zubehör

Für dieses Mikrofon ist folgendes Zubehör erhältlich:
Mikrofonhalterung MZH 604 (Art. Nr. 05299)

Technische Daten

Wandlerprinzip	dynamisch
Übertragungsbereich	40 – 18.000 Hz
Richtcharakteristik	Niere
Freifeldleerlauf- Übertragungsfaktor (1 kHz)	2,0 mV/Pa
Nennimpedanz (bei 1 kHz)	350 Ω
Min. Abschlussimpedanz	1 k Ω
Stecker	XLR-3
Gewicht	125 g
Maße	Ø 41 mm, Länge 63 mm

Übersicht Mikrofonanwendungen

Anwendung	Modell									
	e901	e902	e904	e905	e906	e908B	e908D	e914	e935	e945
Gesang									x	x
Chor								x		
Studio, akustische Instrumente					x			x		
Orchester								x		
Blechbläser / Saxophon		x	x			x				
Akustische Gitarre								x		
Akustischer Bass								x		
Gitarrenverstärker					x					
Bassverstärker		x								
Leslie	x	x	x	x						
Piano, Flügel	x							x		
Kick Drum	x	x								
Snare Drum			x	x	x		x			
Hänge-Tom			x	x	x		x			
Stand-Tom		x	x	x	x		x			
Congas			x		x	x	x			
Becken								x		
Percussion			x	x	x	x	x	x		
Overhead								x		

ENGLISH

High-quality dynamic microphone with cardioid pick-up pattern.

Due to its compact design, the microphone is ideal for use with drums (toms and snares). It can easily be positioned in cramped space conditions (e.g. below the cymbals) and the supplied MZH 604 microphone clamp allows to precisely attach it to the rim of the instrument.

The 904 is also suitable for miking guitar amplifiers, percussions as well as brass and woodwind instruments.

A rugged full metal body effectively protects the microphone from impact damage.

The XLR connector turned by 45° allows the space saving positioning of the microphone in the case of angled connectors.

Features

- Extremely vivid, powerful sound with drums and percussions
- Sound can be shaped as needed to fit all styles of music
- Extremely rugged for rough stage use
- Hum compensating coil protects against electromagnetic interference
- Gold-plated XLR connector (turned by 45°)

Delivery includes

● 904 microphone

Pouch

MZH 604 microphone clamp

Instructions for use

Warranty Certificate

Pin assignment of XLR-3 connector

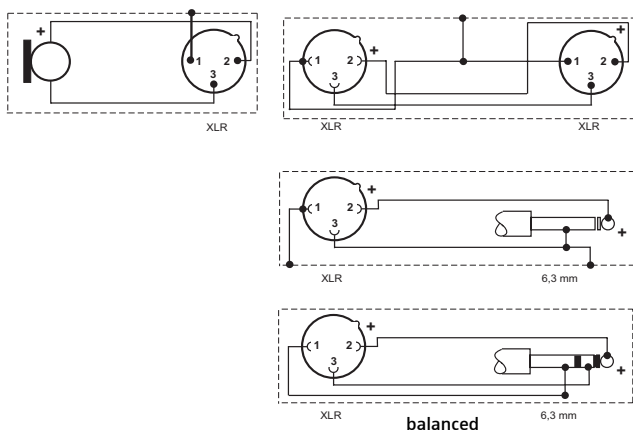

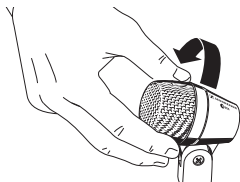

Removing the sound inlet basket



Positioning the microphone

Drums

Position	Resulting sound	Commentary
	More fundamental tone, little overtones	Position on the drum: 3–5 cm above the batter head, the fundamental tone to overtones ratio can be adjusted via the angle. The most balanced results are obtained at an angle of 30–60°.
	Less fundamental tone, many overtones	
		Use of a second 904 for picking up the resonant head and the snares. If necessary, activate phase reversing for one of the microphones.

In order to prevent interference due to crosstalk between adjacent sound sources, try to position the microphone so that the interfering sound source is located in the angle area of the highest cancellation of the microphone (approx. 180°).

Polar diagram

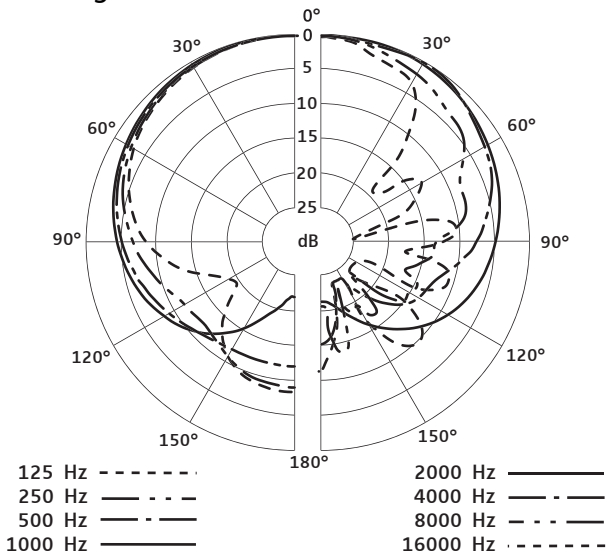

Frequency response curve

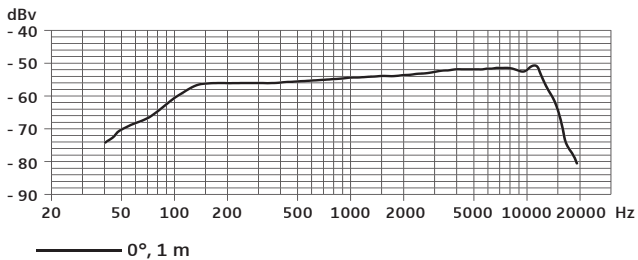

Accessories

The following accessories are available for the 904:
MZH 604 microphone clamp (Cat. No. 05299)

Specifications

Transducer principle	dynamic
Frequency response	40 – 18,000 Hz
Pick-up pattern	cardioid
Sensitivity (free field, no load)	2.0 mV/Pa (at 1 kHz)
Nominal impedance (at 1 kHz)	350 Ω
Min. terminating impedance	1 k Ω
Connector	XLR-3
Weight	125 g
Dimensions	diam.: 41 mm, length: 63 mm

Overview of microphone applications

Application	Variant										
	e901	e902	e904	e905	e906	e908B	e908D	e914	e935	e945	
Vocals									x	x	
Choirs								x			
Studio, acoustic instruments					x			x			
Orchestra								x			
Brass / Saxophone		x	x			x					
Acoustic guitar								x			
Acoustic bass								x			
Guitar amplifiers					x						
Bass amplifiers		x									
Leslie	x	x	x	x							
Piano, grand piano	x							x			
Kick drums	x	x									
Snare drums			x	x	x		x				
Rack toms			x	x	x		x				
Floor toms		x	x	x	x		x				
Congas			x		x	x	x				
Cymbals								x			
Percussion			x	x	x	x	x	x			
Overheads								x			

FRANÇAIS

Microphone dynamique de haute qualité à directivité cardioïde.

Sa conception très compacte le prédestine à la batterie (tom et caisse claire). Il peut être positionné aisément même dans un espace exigu (par ex. sous la cymbale) et fixé de façon simple et précise avec la pince (MZH 604) au bord de l'instrument.

Convient aussi à la prise de son d'amplis de guitare, de percussions, de cuivres et de bois.

Le boîtier métallique protège bien le microphone durant les tournées.

Le connecteur XLR tourné de 45° réduit l'encombrement du microphone en combinaison avec des connecteurs coudés.

Caractéristiques

- Son puissant, très vivant sur les caisses et les percussions
- Excellent rendu quel que soit le style
- Conception très robuste
- Bobine de compensation du ronflement protégeant des perturbations
- Connecteur XLR doré (tourné de 45°)

Fourniture

Microphone ©904

Etui

Fixation MZH 604

Notice d'emploi

Carte de garantie

Brochage XLR-3

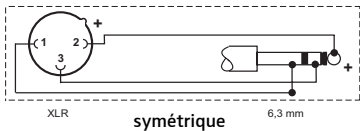
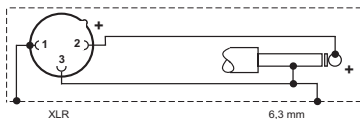
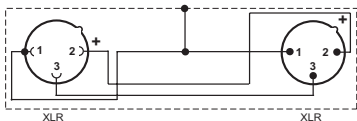
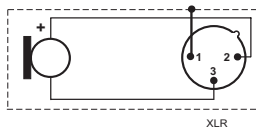



Démontage de la tête de microphone



Mise en place du microphone

Caisses

Positionnement	Tonalité	Commentaire
	Beaucoup de son fondamental, peu de sons harmoniques	Positionnement sur la caisse : 3 - 5 cm au-dessus de la peau, le rapport son fondamental/
	Peu de son fondamental, beaucoup de sons harmoniques	harmoniques peut être réglé par l'angle. Un angle de 30-60° fournit les résultats les plus harmonieux.
		Emploi d'un deuxième microphone 904 pour la prise de son sur la peau de résonance et les caisses claires. Activer si nécessaire la rotation de phase sur un microphone.

Pour éviter des perturbations dues aux interférences de sources sonores voisines, essayez de positionner le microphone de manière que la source parasite se trouve dans l'angle d'atténuation maximale du microphone (approx. 180°).

Diagramme polaire

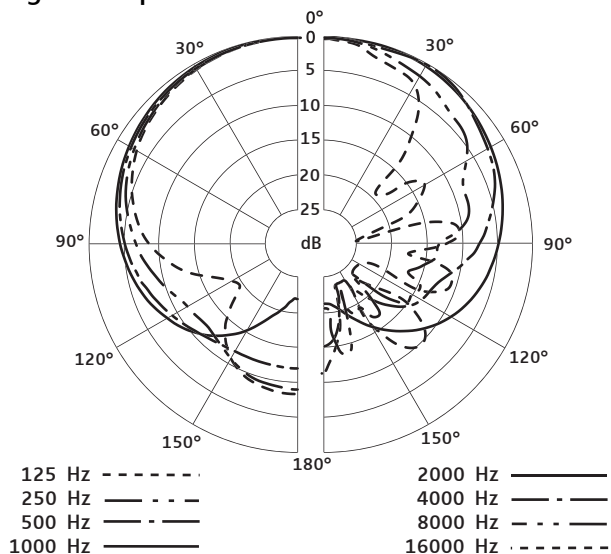

Réponse en fréquence

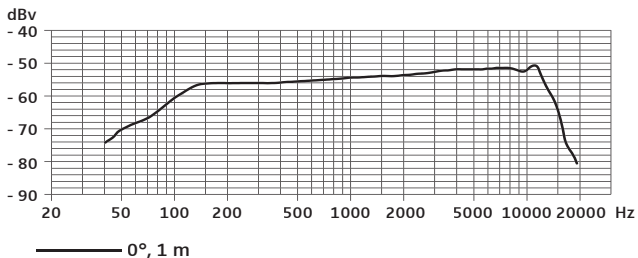

Accessoires

Ce microphone est disponible avec les accessoires suivants :

pince MZH 604 (réf. 05299)

Caractéristiques techniques

Principe transducteur	dynamique
Réponse en fréquence	40 – 18.000 Hz
Directivité	cardioïde
Sensibilité (champ libre, à vide)	2,0 mV/Pa (1 kHz)
Impédance nominale (à 1 kHz)	350 Ω
Impédance de charge minimum	1 k Ω
Connecteur	XLR-3
Poids	125 g
Dimensions	\varnothing 41 mm, longueur 63 mm

Vue d'ensemble des applications de microphones

Application	Modèle									
	e901	e902	e904	e905	e906	e908B	e908D	e914	e935	e945
Chant									x	x
Chœurs								x		
Studio, instruments acoustiques					x			x		
Orchestre								x		
Cuivres / saxophone		x	x			x				
Guitare acoustique								x		
Basse acoustique								x		
Ampli de guitare					x					
Ampli de basse		x								
Leslie	x	x	x	x						
Piano, à queue	x							x		
Grosse caisse	x	x								
Caisse claire			x	x	x		x			
Tom suspendu			x	x	x		x			
Tom sur pied		x	x	x	x		x			
Congas			x		x	x	x			
Cymbale								x		
Percussions			x	x	x	x	x	x		
Overhead								x		

ITALIANO

Microfono dinamico cardioide di elevata qualità.

Grazie alla sua struttura corta è particolarmente adatto per l'uso sulla batteria (tom e cassa chiara). Può essere collocato anche in condizioni di spazio ristretto (ad es. sotto i piatti) e con il supporto del microfono in dotazione (MZH 604) può essere fissato sul bordo dello strumento in maniera semplice e precisa.

Trova buon impiego anche per la registrazione di amplificatori per chitarra, strumenti a percussione come pure strumenti a fiato d'ottone e di legno.

L'alloggiamento metallico protegge il microfono in maniera efficace in caso di uso 'on the road'.

Il connettore XLR ruotabile di 45° consente una disposizione salvaspazio del microfono a spinotti piegati.

Carsuono pieno e potente

- Suono estremamente vivo e d'impatto per tamburi e strumenti a percussione
- Straordinaria possibilità di formazione del suono per tutti gli stili
- Estremamente robusto per l'uso in tournée
- Bobina antironzio contro le dispersioni
- Connettore XLR dorato (ruotato di 45°)

Dotazione di fornitura

Microfono e904

Custodia

Supporto del microfono MZH 604

Istruzioni per l'uso

Scheda di garanzia

Collegamento connettore XLR a 3 poli

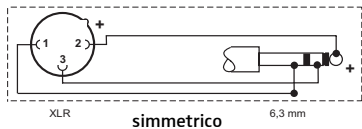
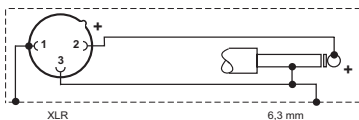
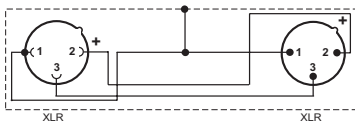
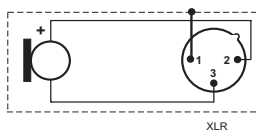



Svitare la testa del microfono



Posizionamento del microfono

Tamburi

Posizionamento	Effetto sonoro	Commento
	Meno tono fondamentale, molti sovratoni	Posizionamento sul tamburo: 3 - 5 cm sopra la pelle, rapporto tono fondamentale - sovratoni regolabile con l'angolo. I risultati più bilanciati si ottengono ad un angolo di 30 - 60°.
	Molto tono fondamentale, meno sovratoni	
		Uso di un secondo C904 per la registrazione della pelle di risonanza e della cassa chiara. Se è presente un solo microfono, attivare eventualmente la trasformazione di fase.

Per evitare disturbi causati dalla sovrapposizione di sorgenti sonore vicine, cercare di posizionare il microfono in modo che la sorgente sonora di disturbo si trovi nell'angolo di cancellazione massima del microfono (circa 180°).

Diagramma polare

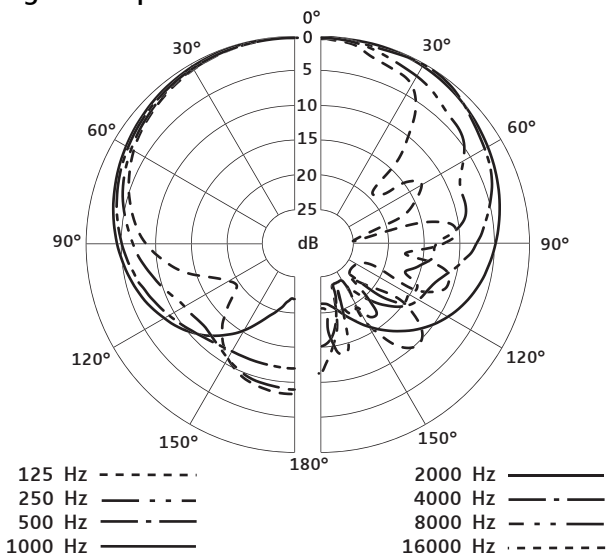

Risposta in frequenza

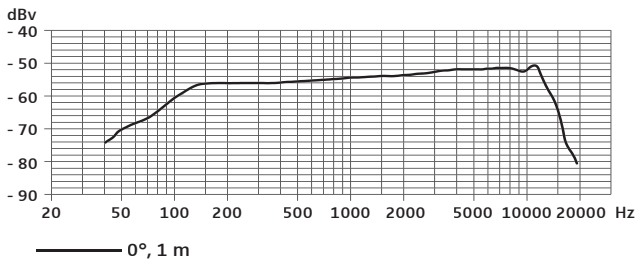

Accessori

Per questo microfono sono disponibili i seguenti accessori: Dispositivo di fissaggio dello strumento MZH 604 (N. art. 05299)

Dati tecnici

Principio di funzionamento	dinamico
Risposta in frequenza	40 – 18.000 Hz
Direttività	cardioide
Sensibilità in campo libero senza carico (ad 1 kHz)	2,0 mV/Pa
Impedenza nominale (ad 1 kHz)	350 Ω
Impedenza minima di carico	1 k Ω
Connettore	XLR-3
Peso	125 g
Dimensioni	\varnothing 41 mm, lunghezza 63 mm

Panoramica degli utilizzi del microfono

Utilizzo	Modello									
	e901	e902	e904	e905	e906	e908B	e908D	e914	e935	e945
Canto									x	x
Coro								x		
Studio, strumenti acustici					x			x		
Orchestra								x		
Ottoni / Sassofono		x	x			x				
Chitarra acustica								x		
Basso acustico								x		
Amplificatore per chitarra					x					
Amplificatore per basso		x								
Leslie	x	x	x	x						
Piano, pianoforte a coda	x							x		
Kick Drum (tamburo a cornice)	x	x								
Snare Drum (cassa chiara)			x	x	x		x			
Tom sospesi			x	x	x		x			
Tom a terra		x	x	x	x		x			
Conga			x		x	x	x			
Piatti								x		
Percussioni			x	x	x	x	x	x		
Overhead								x		

ESPAÑOL

Micrófono dinámico de alta calidad con característica cardioide.

Gracias a su construcción corta es especialmente apto para el uso en la batería (Tom y Snare). Se coloca perfectamente incluso en condiciones de espacio restringidas (p.ej. debajo de los platillos) y se fija de forma sencilla y exacta en el borde del instrumento mediante el soporte de micrófono (MZH 604) adjunto.

También se puede utilizar para el registro de amplificadores de guitarra, instrumentos de percusión, así como instrumentos de viento de metal y de madera.

La carcasa metálica ofrece una protección eficaz para el micrófono para las condiciones duras durante giras.

El conector XLR girado en 45° permite la disposición del micrófono en poco espacio con conectores acodados.

Características

- sonido enormemente vivo y potente en batería y percusión
- excelente moldeabilidad del sonido para todos los estilos
- extremadamente robusto para el duro uso diario durante giras
- bobina de compensación de zumbidos contra interferencias
- conector XLR dorado (girado en 45°)

Volumen de suministro

Micrófono e904

Bolsa

Soporte de micrófono MZH 604

Instrucciones para el uso

Tarjeta de garantía

Asignación de terminales XLR-3

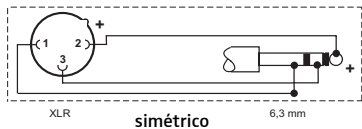
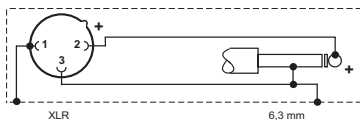
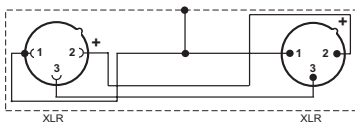
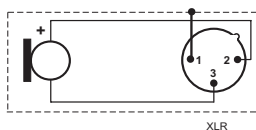



Desmontaje del cesto de registro



Posicionamiento del micrófono

Tambores

Posicionamiento	Resultado	Comentario
	mucho tono fundamental, pocos armónicos	Posicionamiento en el tambor: 3 - 5 cm por encima del parche; la relación entre el tono fundamental y los armónicos se puede ajustar mediante el ángulo. Los resultados más equilibrados se consiguen con un ángulo de 30 - 60°.
	poco tono fundamental, muchos armónicos	
		Uso de un segundo 904 para el registro del parche de resonancia y de los Snares. En un micrófono, activar en su caso el giro de fase.

Para evitar interferencias por diafonía desde fuentes de sonido contiguas, trate de posicionar el micrófono de tal manera que la fuente de interferencia se sitúe en la zona angular de la mayor extinción del micrófono (aprox. 180°).

Diagrama polar

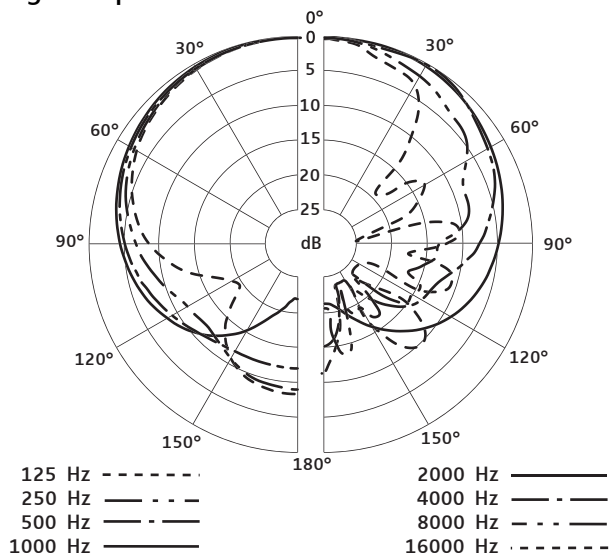

Respuesta de frecuencia

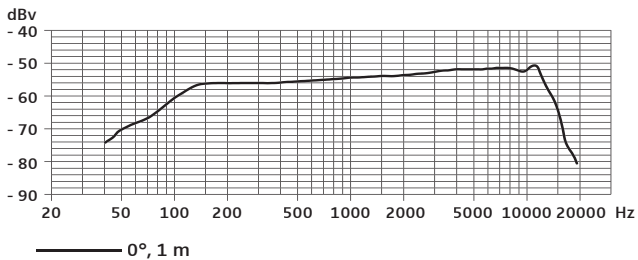

Accesorios

Para este micrófono están disponibles los siguientes accesorios:

Pinza para instrumentos MZH 604 (nº art. 05299)

Datos técnicos

Principio transductor	dinámico
Respuesta	40 – 18.000 Hz
Característica direccional	cardioide
Factor de transmisión neutro (con 1 kHz)	2,0 mV/Pa
Impedancia nominal (con 1 kHz)	350 Ω
Impedancia terminal mín.	1 k Ω
Conector	XLR-3
Peso	125 g
Medidas	\varnothing 41 mm, longitud 63 mm

Vista general de las aplicaciones del micrófono

Aplicación	Modelo										
	e901	e902	e904	e905	e906	e908B	e908D	e914	e935	e945	
Canto									x	x	
Coros								x			
Estudio, instrumentos acústicos					x			x			
Orquesta								x			
Instrumentos de metal / saxofón		x	x			x					
Guitarra acústica								x			
Bajo acústico								x			
Amplificador de guitarra					x						
Amplificador de bajo		x									
Leslie	x	x	x	x							
Piano, piano de cola	x							x			
Kick Drum	x	x									
Snare Drum			x	x	x		x				
Tam-tam suspendido			x	x	x		x				
Tam-tam con pie		x	x	x	x		x				
Congas			x		x	x	x				
Platillos								x			
Percusión			x	x	x	x	x	x			
Overhead								x			

NEDERLANDS

Hoogwaardige dynamische microfoon met nierkarakteristiek.

Door zijn korte bouwwijze is hij bijzonder goed geschikt voor het gebruik aan het drumstel. Hij kan ook op enge plaatsen (b.v. onder bekkens) goed geplaatst worden en met de bijgeleverde microfoonhouder (MZH 604) op een eenvoudige en precieze manier aan de instrumentenrand bevestigd worden.

Ook voor de opname van gitaarversterkers, percussie-instrumenten alsook koperen instrumenten en houten blaasinstrumenten kan hij goed gebruikt worden.

De metalen behuizing beschermt de microfoon op een doeltreffende manier tegen het ruwe roadgebruik.

De 45° gedraaide XLR-stekker maakt een plaatsbesparende positie van de microfoon bij afgeschuinde stekkers mogelijk.

Eigenschappen

- enorm levendig, vol geluid bij drums en percussie
- uitstekende vormbaarheid van het geluid voor alle stijlrichtingen
- extreem robuust voor het ruwe alledaagse touren
- bromcompensatiespoel tegen storingen
- vergulde XLR-stekker (45° gedraaid)

Omvang levering

Microfoon  e904

Microfoonhouder MZH 604

Hoes

Gebruiksaanwijzing

Garantiebewijs

Aansluitbezetting XLR-3

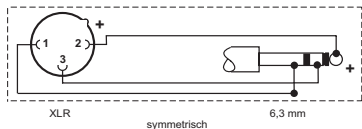
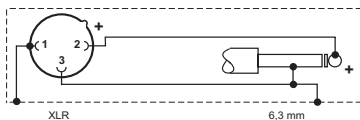
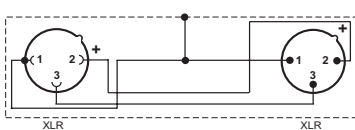
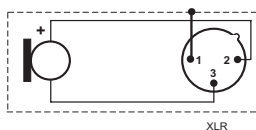

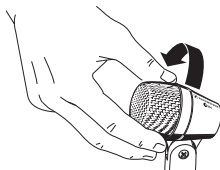

Spreekorf losdraaien



Microfoon plaatsen

Trommels

Positionering	Klankresultaat	Commentaar
	veel grondtonen, weinig boventonen	Positionering bij de trommel: 3 - 5 cm boven het vel, de verhouding grondtoon/boventoon kan door middel van de hoek worden ingesteld.
	weinig grondtonen, veel boventonen	De beste resultaten bereikt men met hoeken van 30 - 60°.
		Gebruik van een tweede C904 voor de opname van het resonantievel en de snaar. Bij een microfoon evt. faseomkering activeren.

Om stringen door overmodulatie van naastgelegen geluidsbronnen te vermijden, moet u de microfoon zo positioneren, dat de stringbron in het gebied met de minste storing van de microfoon ligt (ca. 180°).

Pooldiagram

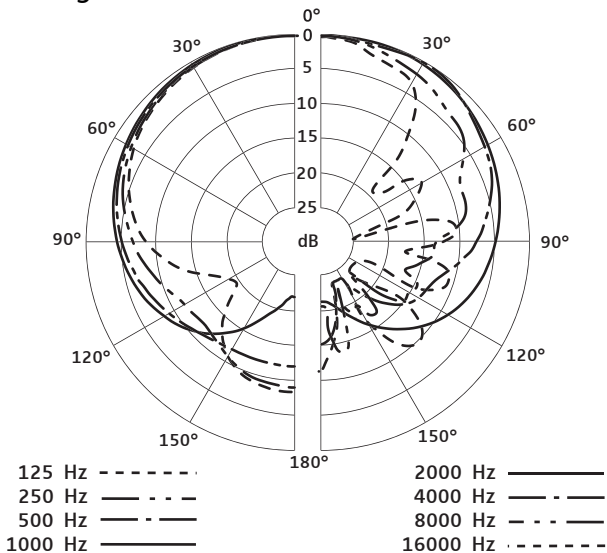

Frequentiesnelheid

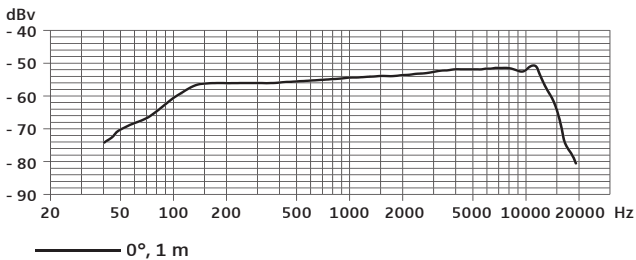

Toebehoren

Voor deze microfoon zijn de volgende toebehoren verkrijgbaar:

Instrumentenklem MZH 604 (art.nr. 05299)

Technische gegevens

Omvormerprincipe	dynamisch
Frequentiebereik	40 – 18.000 Hz
Richtkarakteristiek	Nier
Onbelaste werking	
frequentiefactor veld (bij 1 kHz)	2,0 mV/Pa
Nom. impedantie (bij 1 kHz)	350 Ω
Min. afsluitimpedantie	1 k Ω
Stekker	XLR-3
Gewicht	125 g
Afmeting	\emptyset 41 mm, Lengte 63 mm

Overzicht van microfoon toepassingen

Toepassing	Model									
	e901	e902	e904	e905	e906	e908B	e908D	e914	e935	e945
Zang									x	x
Koor								x		
Studio, akoestische instrumenten					x			x		
Orkesten								x		
Koperblazers/saxofoons		x	x			x				
Akoestische gitaren								x		
Akoestische bas								x		
Gitaarversterker					x					
Basversterker		x								
Leslie	x	x	x	x						
Piano, vleugel	x							x		
Kick drum	x	x								
Snaredrum			x	x	x		x			
Hangende tom			x	x	x		x			
Staande tom		x	x	x	x		x			
Conga's			x		x	x	x			
Bekken								x		
Percussie			x	x	x	x	x	x		
Overhead								x		

Konformitätserklärung

Sennheiser electronic GmbH & Co. KG erklären, dass dieses Gerät die anwendbaren CE-Normen und Vorschriften erfüllt.

Approval

Sennheiser electronic GmbH & Co. KG declare that this device is in compliance with the applicable CE standards and regulations.

Certification

Sennheiser electronic GmbH & Co. KG déclarons que cet appareil est en conformité avec les normes CE.

Certificazione

Sennheiser electronic GmbH & Co. KG dichiara che questo apparecchio risponde alle normative e alle prescrizioni CE applicabili.

Autorización

Sennheiser electronic GmbH & Co. KG declara que este aparato cumple las normas y directrices de la CE aplicables.

Vergunning

Sennheiser electronic GmbH & Co. KG verklaren, dat dit toestel voldoet aan de toepasselijke CE-normen en voorschriften.

Diese Service-Nummer gilt nur für Deutschland



K . I . S . S .

Kunden-Informationssystem-Sennheiser

0180 / 5221 539

0,12 € je Minute

Montag -Freitag: 8.00 Uhr - 18.00 Uhr



Sennheiser electronic GmbH & Co. KG
30900 Wedemark, Germany
Phone +49 (5130) 600 0
Fax +49 (5130) 600 300
www.sennheiser.com