



Specifications: FP6020-II

System Type	2 x 25 mm stereo or mono high-directivity (8 ohm stereo, 4 ohm mono). Optional transformer for distributed systems (25/70.7/100-volt).
Impedance (nominal) ¹	8 ohm stereo, 4 ohm mono
Sensitivity dB @ 2.83 V/1 m	75.0 dB
Sensitivity dB @ 1 W/1 m ²	75.0 dB
Frequency Response (-3 dB) ³	170 Hz - 22 kHz (300 Hz with high-pass filter)
Frequency Response (-10 dB) ³	130 Hz - 22 kHz (200 Hz with high-pass filter)
Max. Program Power ⁴	30 W
Max. Continuous Power RMS ⁵	15 W
Max. Power SPL @ 1 m ⁶	87.0 dB
Coverage Angle (-6 dB @ 2 kHz)	30°
Coverage Angle (-6 dB @ 10 kHz)	55°
Coverage Angle (Avg. 2 to 10 kHz)	45°
Directivity Factor (Q)	19 (averaged 100 Hz - 10 kHz); 20.9 (2 kHz)
Directivity Index (DI)	11.9 dB (averaged 100Hz - 10kHz); 13.2 dB (2 kHz)
Tap Selector	Optional J-box transformer with four-position rotary switch
Transducers	Twin 25 mm (1.0 in) full-range aluminum concave
Low-Frequency Voice Coil	20.5 mm (0.81 in)
High-Pass Filter	75 Hz or 350 Hz switchable
Network Type: High-Pass	6 dB per octave, 1st order
Dome Material	Clear PETG dome
Grille and Enclosure Material	High-impact polystyrene
Inputs	Four-conductor 16-gauge hardwire leads, CAT-V cable included for optional accessories
Colors	Clear dome, black pod, optional black or white domes available
Height	222.3 mm (8.75 in)
Dome Diameter	514.4 mm (20.25 in)
Weight	2.5 kg (5.5 lbs)
Shipping Weight	5 kg (11.0 lbs)
Packaging	One per box, bulk packaging available
Accessories (Included)	Hanging hardware, mounting bushing and 15-foot hardwire lead
Accessories (Optional)	Motion sensor (FP-Motion), LED light (FP-Light), FP-ScentAir™ and amplifier (FP-Amp). Additional accessories include 15-volt, 5-amp or 15-volt, 3-amp power supply (AC-PS-1550 or AC-PS-1530), 10- or 20-watt transformers with junction boxes for 25-, 70.7- and 100-volt applications (AC-JB10-XFMR, AC-JB20-XFMR), external amplification unit with power supply (SA202-RDT), wall bracket (AC-WB4), and rigid mount adaptors (AC-FP6-RMA).
Regulatory - CE	Approved
RoHS	Approved

¹ Impedance listed per IEC 60268-5 with a minimum less than 80% the nominal impedance

² 1 W/1 m sensitivity determined using nominal impedance

³ Frequency response measured in half or full space as dictated by speaker mounting

⁴ configuration

⁵ Max program power is 3 dB above max continuous power

⁶ Continuous power rating, EIA-426-B test

Max output based on max continuous power

Optional Transformer Taps (Using AC-JB10-XFMR)

70.7 V	Output	100 V	Output	25 V	Output
10 W	85.0 dB	10 W	85.0 dB	1.25 W	76.0 dB
5 W	82.0 dB	5 W	82.0 dB	.63 W	73.0 dB
2.5 W	79.0 dB	2.5 W	79.0 dB	.32 W	70.0 dB
1.25 W	76.0 dB			.16 W	67.0 dB

Key Features

- Patented Dual-Parabolic™ dispersion control technology provides a targeted audio footprint with true stereo separation.
- Twin 1.00 in (25 mm) concave aluminum high-excursion drivers in individually sealed compartments for stereo or mono music and messaging.
- Patented ZeroReflection™ enclosure technology for accurate sound reproduction.
- Narrow 30° coverage angle for sharp focus (2 kHz, independently verified).
- 20.25 in (514.3 mm) custom-molded PETG clear polymer dome for minimal visual impact.
- User-selectable 350 Hz high-pass filter.
- Single-point balanced mounting for easy and clean-looking installs.
- Ships with clear dome, custom colors available.
- Included accessories: hanging bracket, mounting bushing and a 15-foot hanging cable which includes four 16-gauge inputs and a CAT V cable.
- Optional modules include motion sensor (FP-Motion), LED light (FP-Light) amplification (FP-Amp), and scent unit (FP-ScentAir™); optional 15-volt, 5-amp or 15-volt, 3-amp power supply necessary for all module accessories (AC-PS-1550 or AC-PS-1530). The FP-ScentAir ships plumbed for scent unit (scent unit sold separately, visit www.scentair.com for details).
- Optional electronic accessories include 10- and 20-watt transformers with junction box for 25-, 70.7- and 100-volt applications (AC-JB10-XFMR, AC-JB20-XFMR) and an external amplification unit with power supply (SA202-RDT) for use with any FP module.
- Additional optional accessories include: wall bracket, sound sleeves and rigid mount adaptor.
- Ships as individual unit, bulk shipping available.

Description

The FP6020-II delivers targeted audio in a unique package by incorporating two full-range, high-performance, 1-inch, concave, aluminum dome, high-excursion drivers with patented 20.25-inch



Dual-Parabolic™ sound domes. All models can be wired in either 8 ohm stereo or 4 ohm mono with an optional 25/70.7/100-volt transformer available.

FP-Specific Modular Options

SoundTube-engineered modular options enhance and expand FP series performance characteristics and applications. Modules include motion sensor (FP-Motion), LED light (FP-Light), amplification (FP-Amp) and the FP-ScentAir™, which delivers scented marketing solutions in an audio package. A 15-volt, 5-amp or 15-volt, 3-amp power supply (AC-PS-1550 or AC-PS-1530) is required for optional modules. A single AC-PS-1550 or AC-PS-1530 will power one or any combination of modules.

FP-Motion

The motion sensor (FP-Motion) module has instant on and time-delayed off triggers. The time delay is installer-adjustable and ranges from 1 to 12 seconds. The FP-Motion includes a stereo signal path relay that completes the audio circuit to deliver sound when motion is detected. To trigger external devices, the motion sensor includes a 12-volt output signal and contact closure.

FP-Light

The light option (FP-Light) delivers a natural warm LED light, which can be used in conjunction with the motion sensor and amp, but not the ScentAir™. Light intensity is governed either globally (externally) or locally via an onboard brightness control centered on the motherboard. To activate the light with motion, the FP-Motion module may be used. FP-Light module specs listed below.

color: warm white
color temperature: 3100K
Max brightness: 75 lumens
Beam pattern: 120 degree
Power draw: 2w

FP-Amp

The 20-watt-per-channel digital stereo amp (FP-Amp) is highly functional and easy to use. The FP-Amp gain can be controlled either globally (externally) or locally. To maximize output and fidelity while minimizing distortion, the FP-Amp incorporates a factory-preset digital

equalizer and driver protection circuitry. The FP-Amp signal is accepted from either a stereo input via four 16-gauge hardwire leads or a built-in microSD card reader (microSD card included). As a default, the FP-Amp accepts input from the signal wires unless a message is installed on the SD card. The microSD reader accepts .wav or .mp3 formats and will play the message continuously (unless used with motion sensor or external trigger).

FP-ScentAir™

The FP-ScentAir™ ships with the motion sensor and is pre-plumbed for use with a ScentAir™ (scent unit sold separately). It may be used in conjunction with the amplifier for maximum audio output and intelligibility. The ScentAir™ scent unit must be purchased through an authorized ScentAir™ reseller. Visit www.scentair.com for more information.

Additional accessories include 10- and 20-watt transformers with junction boxes for 25-, 70.7- and 100-volt applications (AC-JB10-XFMR, ACJB20-XFMR) and an external amplification unit with power supply (SA202-RDT).

Applications

High-definition music and messaging with tight coverage, full-range stereo sound (130 Hz – 22 kHz, -10 dB) and true audio containment (45° averaged, 2 - 10 kHz) make the FP6020-II the ideal choice for focused audio applications including kiosks, P.O.P. displays, trade shows, digital signage or anywhere contained high-fidelity stereo or mono sound is required but visual impact must be minimized.

Patented Dual-Parabolic™ Technology

By incorporating patented Dual-Parabolic™ dome technology, the FP series provides a targeted hot-spot with definitive stereo separation. With sound waves projected into the dome, SoundTube's proprietary technology reflects sound waves from the mid and upper registers of the frequency spectrum directly beneath the dome.

SoundTube Entertainment and the MSE Audio Group constantly develop new technologies, which enhance audio product performance. SoundTube Enter-

tainment innovations are protected by multiple U.S. and international patents, which explicitly cover SoundTube dome, enclosure and dispersion technologies. The MSE Audio Group actively defends its patents in order to protect SoundTube resellers and end-users.

Technical Data and Specification Tools

Technical Data

SoundTube Entertainment strives to provide complete and effective technical information and data to dealers, engineers and designers. All data are available from SoundTube Entertainment or at www.soundtube.com.

Technical data and downloads include:

EASE™ data – 3-D polar plots.

EASE™ Address – 2-D modeling for distributed systems

Autodesk® Revit® software

Tech Sheets – Technical information and architectural specs for system engineers

SoundTubeSPEC™ – Proprietary speaker placement software

Independent Data Acquisition and Verification

All data for SoundTube speakers are independently collected and verified by NWA Labs (www.nwaalabs.com) using their proprietary MACH testing system. All data are collected and analyzed according to ASTM, ISO and AES standards using EASERA, TEF and MLSSA. Full balloon data including both phase and magnitude are compiled into a variety of formats including EASE 4.x, GLL and CLF.

Architectural Specifications

The loudspeaker shall consist of two 25 mm (1.0 in) transducers with a voice coil diameter of 20.5 mm (0.81 in). Sound waves from the transducers shall be reflected from a 514.3 mm (20.25 in) Dual-Parabolic™ sound dome.

Performance specifications of a typical unit shall be as follows: Useable frequency response shall extend from 130 Hz – 22 kHz (-10 dB). Measured sensitivity (2.83-volt input, 1 meter) shall be at least 75 dB stereo. The loudspeaker

Frequency Response

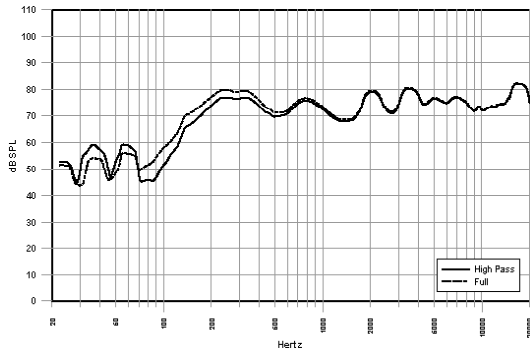

Impedance/Phase

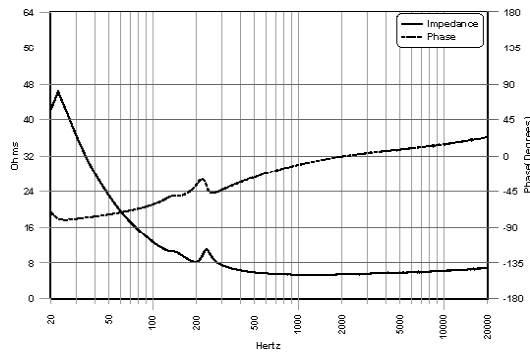

Vertical Beamwidth

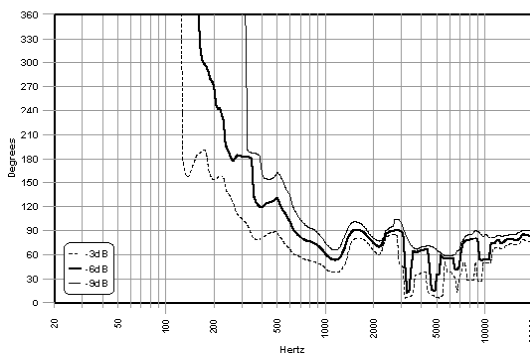

Directivity Index (DI)

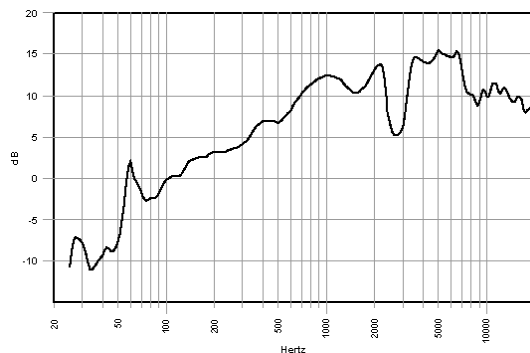

shall ship with a CAT V cable and four 16-gauge hardware leads and be available in 8 ohm impedance mode (4 ohm if bridged/mono), or with an optional 25/70.7/100-volt transformer and accompanying junction box. For the transformer accessory, the transformer unit and four-position tap switch will be supplied in a junction box.

The dome shall be constructed of custom-molded PETG. The driver shall have a high-impact polystyrene enclosure. The transducers shall have a concave aluminum diaphragm with high-impact polystyrene transducer protectors. The overall unit dimensions shall be no more than 514.3 mm (20.25 in) in diameter by 222.3 mm (8.75 in) in height and weigh no more than 2.5 kg (5.5 lbs).

Installation for the speaker shall be by single-point hanging with the cable affixed to a mounting bushing and hanging bracket.

Optional modules include motion sensor (FP-Motion), LED light (FP-Light) and Amplifier (FP-Amp); the FP-ScentAir™ ships plumbed to accept scented marketing solutions. All optional FP modules require one AC-PS-1550 or AC-PS-1530 power supply to power one or any combination of modules.

Optional electronics accessories include 10- and 20-watt transformers with junction box for 25-, 70.7- and 100-volt applications (AC-JB10-XFMR, AC-JB20-XFMR) and an external amplification unit with power supply (SA202-RDT). Also available are custom printed sound sleeves, wall brackets (AC-WB4) and rigid mount adaptors (AC-FP6-RMA).

The system shall be the SoundTube FP6020-II for both low- and high-impedance applications.

SoundTube Entertainment

6430 Business Park Loop Road
 Park City, Utah 84098
 Phone 435.647.9555
 Fax 435.647.9666
 Toll Free 800.647.TUBE
 www.soundtube.com

All SoundTube products come with a 5-year limited warranty.

FP6020-II

Sound-Focusing Speaker
 Technical Information for System Engineers



SOUNDTUBE
 ENTERTAINMENT

Polar Plots

— Horizontal
 - - - Vertical

125 Hz

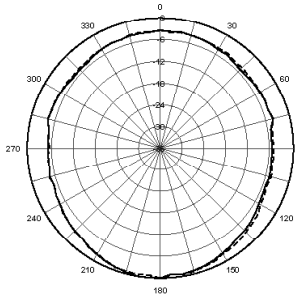

250 Hz

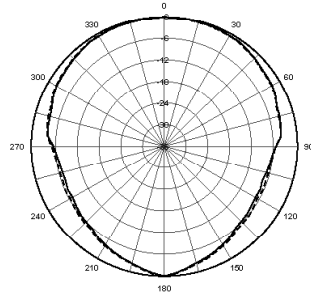

500 Hz

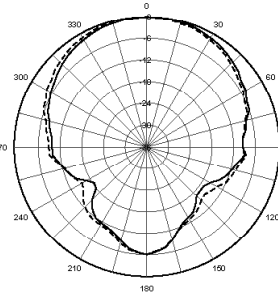

1,000 Hz

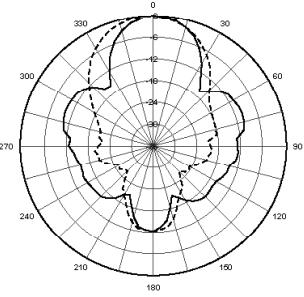

2,000 Hz

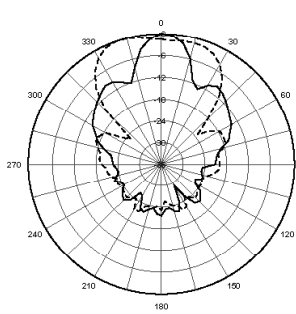

4,000 Hz

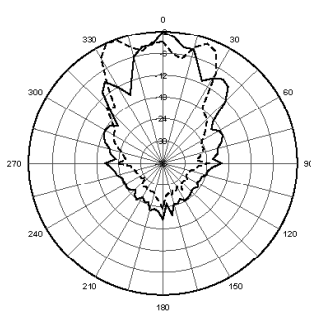

8,000 Hz

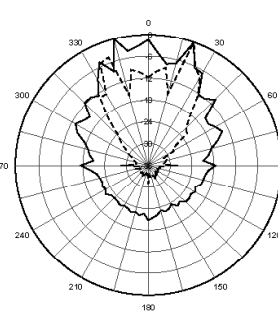

10,000 Hz

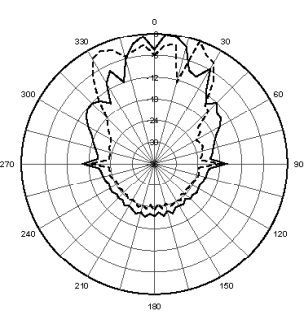

Technical data, EASE™ plots, SoundTubeSPEC™ software and product downloads available at www.soundtube.com

Mechanical Drawings

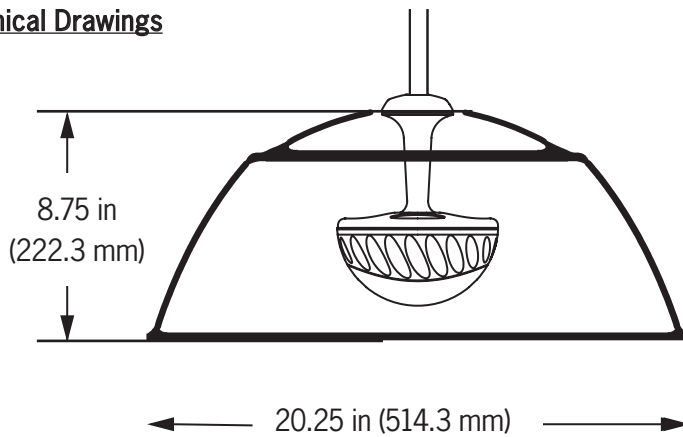

Included Accessories

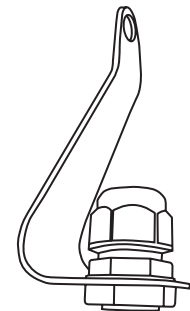

Cable hanging bracket and mounting bushing

Optional Accessories



AC-CFP Custom-Printed SoundSleeve™

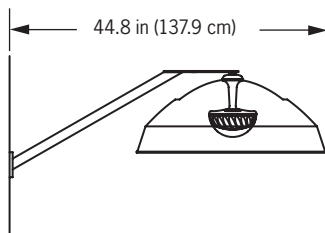

AC-WB4 Wall-Mount Bracket

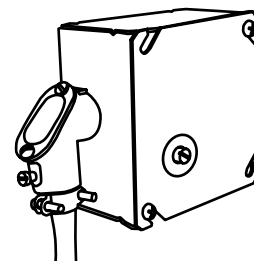

AC-JB10-XFMR & AC-JB20-XFMR
 10- and 20-watt transformers in junction boxes

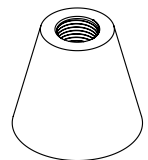

AC-FP6-RMA
 Rigid-Mount Adaptor

SoundTube Entertainment manufactures a complete line of speakers for:
Open-Ceiling • In-Ceiling • Surface-Mount • Outdoor • Sound-Focusing

All SoundTube products are designed and engineered in the USA.