



MIXING CONSOLE
MG Series

MG06 MG10 MG12 MG16 MG20
MG06X MG10XU MG12XU MG16XU MG20XU

YAMAHA CORPORATION
P.O.BOX1, Hamamatsu Japan
www.yamahaproaudio.com

*All specifications are subject to change without notice. *All trademarks and registered trademarks are property of their respective owners.



LPA631

P10026356

Printed in Japan

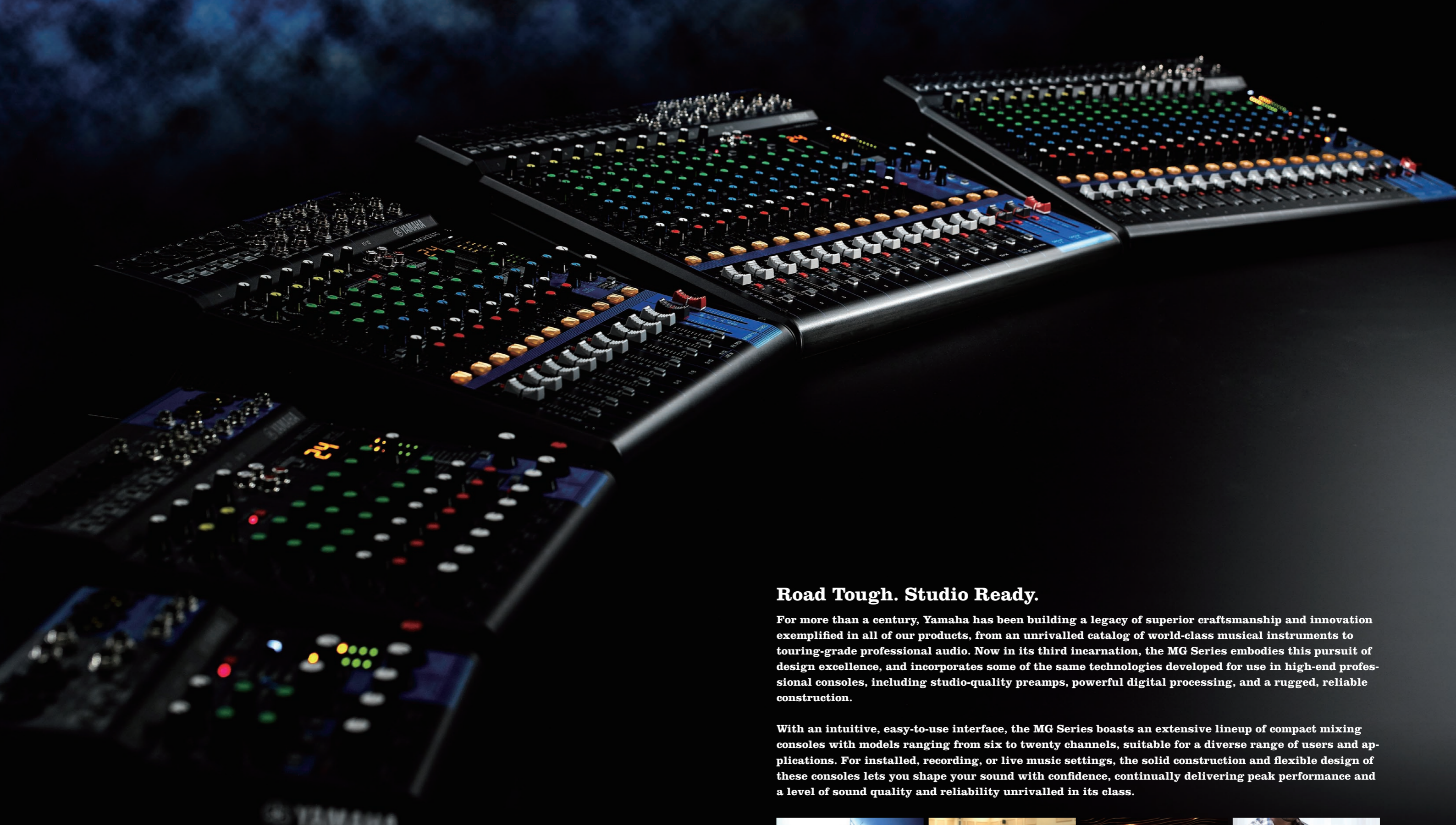

Road Tough. Studio Ready.

For more than a century, Yamaha has been building a legacy of superior craftsmanship and innovation exemplified in all of our products, from an unrivalled catalog of world-class musical instruments to touring-grade professional audio. Now in its third incarnation, the MG Series embodies this pursuit of design excellence, and incorporates some of the same technologies developed for use in high-end professional consoles, including studio-quality preamps, powerful digital processing, and a rugged, reliable construction.

With an intuitive, easy-to-use interface, the MG Series boasts an extensive lineup of compact mixing consoles with models ranging from six to twenty channels, suitable for a diverse range of users and applications. For installed, recording, or live music settings, the solid construction and flexible design of these consoles lets you shape your sound with confidence, continually delivering peak performance and a level of sound quality and reliability unrivalled in its class.



Head of the class

Yamaha has always strived to provide sound engineers with the purest possible signal instead of added processing or color to give it a “signature” sound, and the MG Series is no exception. Embracing this philosophy of transparent sound, these mixing consoles deliver a level of sonic purity and sound quality that is unmatched in their class.

D-PRE Discrete Class-A Mic Preamps

This is where it all starts. Everything you do as a sound engineer is dependent on the quality of your preamps, which determines the direction your mix will take, and ultimately how good it is going to sound. MG Series mixing consoles feature Yamaha’s studio-grade discrete class-A D-PRE preamps, which utilize an inverted Darlington circuit comprising two cascading transistors in a configuration that provides more power with lower impedance. Delivering fat, natural sounding bass and smooth, soaring highs, with very low distortion, D-PRE preamps possess an impressively wide frequency range that allow them to handle signal from any audio source without overly amplifying any specific elements of the sound. Having such a pure sonic platform to build on will ultimately save you time and effort by eliminating the need for excessive EQing or additional effects processing in order to “fix” your mix.

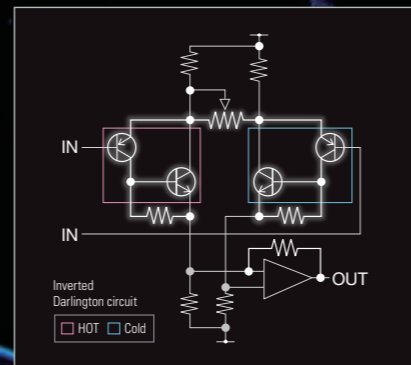

High Quality Sound Op-amp

The head amp determines sound quality, and op-amp integrated circuits are one of the most important parts in the head amp circuit. MG Series mixers feature new, high-quality, custom-made MG01 op-amps that we developed in cooperation with the semiconductor manufacturer. Although many other Op-amps prioritize electrical design and efficiency, we worked directly with the semiconductor manufacturer to focus on sound quality first. MG01 op-amps feature redesigned circuitry in which even the internal components and wiring have been optimized, and use materials such as high-quality silicon wafers and copper wire to achieve superb resolution.

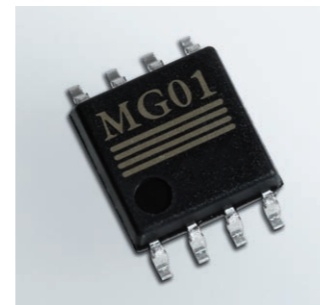

Switchable Phantom Power & PAD Switch

With phantom power, MG Series consoles allow you to take full advantage of the greater frequency response and high sound quality of condenser microphones. The input channel with PAD switch accepts MIC to line level of inputs, PAD Switch attenuates high input signals that often accompany mic'd instruments during performance, avoiding the clipping that can seriously affect your mix.



Our mixer. Your sound.

When was the last time you heard guitar without EQ or a completely unprocessed vocal on one of your favorite songs? Probably never. Yamaha mixers are famous for their flat response and sonic purity, but it often takes more than a perfectly-captured instrumental performance or vocal to achieve a professional-sounding mix. Equipped with some of the same state-of-the-art functionality featured on Yamaha's high-end consoles, the MG Series gives you the tools you need to produce high quality sound that is uniquely your own.



1-knob Compressors

Compression plays an essential role in just about any recording or sound reinforcement environment by altering the level of dynamics of an audio signal when you need livelier guitars, punchier bass lines, a tighter snare, or a cleaner vocal sound. However, it can take countless hours to master the complexities of even the most basic outboard compression units and use them effectively. Originally a Yamaha innovation, 1-knob compressors are now an industry standard that gives you instant access to optimized compression settings via a single rotary control.



EQ and High-pass Filters

There's nothing more useful than reliable equalization when you need nuanced management of your tone. The MG Series benefits from Yamaha's unparalleled experience in designing pro audio gear, featuring 3-band equalizers on all mono channels for precise control of your sound. High-pass filter allows you to eliminate unwanted low-frequency noise, for a smoother, cleaner mix.

AUX / Effect Sends / Group

MG Series mixers feature up to AUX sends for expanding your sound reinforcement or recording setup, allowing you to incorporate additional effects, output to external recording devices, or feed to an monitoring system. Master send controls are also provided. The MG06 / 06X and MG10 / 10XU have a single stereo bus. All other models additionally feature one or two stereo group buses and outputs that can be used for convenient channel grouping. Assign switches for the stereo and group buses are located next to each channel fader.



Built-in SPX Digital Effects

For musical and non-musical applications alike, effects processing adds polish and professionalism to the mix. The MG X / XU models features Yamaha's acclaimed SPX digital multi-effect processor, offering a comprehensive suite of 24 editable digital effects perfect for enhancing your mix, whether adding depth to a speaking engagement or breathing new color and atmosphere into a live band performance. In particular, the high-quality reverb and delay expand the spatial quality of the sound with remarkable realism and naturalness. You can even connect an optional FC5 foot switch for effect on / off control. (MG10XU / 12XU / 16XU / 20XU)

A variety of input / output connectors

All models feature high-quality Neutrik™ balanced XLR connectors on mono microphone/line channels and XLR equipped stereo channels. Each of the mono inputs is equipped with combo jack and accepts both MIC and LINE level signals. Two of the stereo inputs are equipped with XLR and two phone connectors with XLR accepting MIC level signals while two phone connectors accepting LINE level signals and can be used either mono or stereo. (except for 10ch model) The function of another two stereo channel vary depending on model: With 20ch model, XLR accepts MIC level signal and two RCA connectors accepts LINE level signals and can be used either mono or stereo. With 16ch and 12ch models, two phone connectors accept LINE level signals as stereo. Additionally, each of the stereo channel features 2TR in (RCA connectors) and can be used as independent input from external audio sources such as CDs. 10ch is equipped with additional stereo channel with a pair of phone jack that accepts LINE levels. With XU models, any incoming source that are sent via USB can be assigned to one of the stereo channel. In addition to the main stereo outputs (XLR L/R, TRS phone L/R), MG Series mixing consoles are equipped with a comprehensive suite of output connectors, including GROUP OUT (TRS phone), AUX/FX OUT (TRS phone), MONITOR OUT (TRS phone L/R), and HEADPHONE OUT (stereo phone) connectors, allowing master outputs to be chosen to suit specific applications such as monitoring or mastering.

LED level metering

Easy-to-read LED level metering allows output levels to be monitored with precision.

[MG10XU / MG12XU / MG16XU / MG20XU]

No.	Program	Parameter	No.	Program	Parameter	No.	Program	Parameter
1	REV HALL 1	Reverb Time	9	EARLY REF	Room Size	17	CHORUS 1	LFO* Freq
2	REV HALL 2	Reverb Time	10	GATE REV	Room Size	18	CHORUS 2	LFO* Freq
3	REV ROOM 1	Reverb Time	11	SINGLE DLY	Delay Time	19	SYMPHONIC	LFO* Freq
4	REV ROOM 2	Reverb Time	12	DELAY	Delay Time	20	TREMOLO	LFO* Freq
5	REV STAGE 1	Reverb Time	13	VOCAL ECHO	Delay Time	21	AUTO WAH	LFO* Freq
6	REV STAGE 2	Reverb Time	14	KARAOKE	Delay Time	22	RADIO VOICE	Cutoff Offset
7	REV PLATE	Reverb Time	15	PHASER	LFO* Freq	23	DISTORTION	Drive
8	DRUM AMB	Reverb Time	16	FLANGER	LFO* Freq	24	PITCH CHANGE	Pitch

MG06X features six SPX effects (REVERB HALL / ROOM / PLATE, DELAY SHORT / LONG / VO.ECHO), which are not editable. * "LFO" stands for Low Frequency Oscillator. An LFO is normally used to periodically modulate another signal, using different waveform shapes and modulation speeds.

Built to last

For gigging, recording, and installed applications alike, your console can be subjected to a wide range of environmental conditions and hazards. Excessive humidity, unstable power supplies, and the rigors of road travel in general can take a serious toll on a mixing console, often causing expensive, time-consuming repairs, and reducing its lifespan. The MG Series has been redesigned with an emphasis on durability, incorporating practical features that offer greater flexibility while ensuring peak performance for many years to come.



Metal Chassis

Built to last, MG Series mixers feature a rugged, impact-resistant, powder-coated metal chassis, offering an unrivalled level of durability. With a sleek design contoured for optimal convection cooling, the internal layout separates the power supply from the analog circuitry for superior noise reduction, and further extends the life of the components inside. To further ensure reliable performance, knob control placement above the surface of the chassis diverts any impact or pressure on the knobs to the chassis itself and not the circuit board or components underneath.



Internal Universal Power Supply (MG12 / 16 / 20 / 12XU / 16XU / 20XU)

Thanks to a highly-efficient internal universal power supply, MG Series consoles offer worry-free operation in any region around the globe—even in environments prone to potentially damaging power fluctuations. An internal power supply also simplifies rack mounting of the console for installed applications, eliminating the need for a bulky adapter or additional connections.



Rack Mount Kit Included (MG16 / 20 / 16XU / 20XU)

Easily adaptable to a diverse range of installed and portable applications, the 16- and 20- channel models of the MG Series included rack ears, giving you the option of a rack-mounted or desk-top configuration. Extremely durable, their sleek design makes safe, stable placement of your console hassle-free, keeping setup time and effort to a minimum.



XLR connector

The main stereo outputs feature XLR type connectors that lock to prevent accidental disconnection. Rugged and dependable, these professional connectors ensure providing stable signal transmission even in the most demanding environments.

Options



Rack Mount Kit **RK-MG12**
(MG12 / MG12XU)



Mic Stand Adaptor **BMS-10A**
(MG06 / MG06X / MG10 / MG10XU)



Foot Switch **FC5**
(MG10XU / MG12XU / MG16XU / MG20XU)

Create, record... listen

The MG Series features the same digital connectivity that is used to streamline the recording process on Yamaha's professional-level mixing consoles. Take advantage of state-of-the-art digital technology that makes it easier than ever to plug-in, play, record, and then listen to your creations.



24-bit/192kHz 2-in/2-out USB Audio Interface Function



MG Series mixing consoles feature flexible digital connectivity for quick and easy high-resolution playback of digital content. Simply connect to your PC via USB, or to your iPhone / iPad (2 or later) using Apple's Camera Connection Kit / Lightning to USB Camera Adapter. The USB protocol uses asynchronous data transfer. Audio data is transferred based on highly precise audio clock signal from the MG, for high quality recording and playback. You can view the latest operating environment at the Yamaha Pro Audio website (URL below).

http://www.yamahaproaudio.com/mg_xu/

* Apple, iPhone, iPad, Camera Connection Kit, and Lightning to USB Camera Adapter are trademarks of Apple Inc., registered in the U.S. and other countries. All other product and company names are ™ and/or ® of their respective holders. All rights reserved.



Cubase AI (MG10XU MG12XU MG16XU MG20XU)



MG XU models are bundled with Downloadable Steinberg's Cubase AI software. As one of the most advanced, comprehensive DAW suites available, Steinberg's Cubase has led the charge, providing users with a powerful and flexible platform for music production. Cubase AI offers these same core technologies and interface that have won Cubase worldwide acclaim.

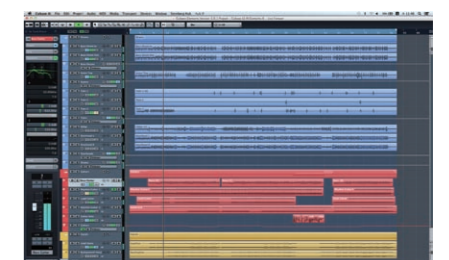

MIXING CONSOLE

MG Series

MG06 MG10 MG12 MG16 MG20
MG06X MG10XU MG12XU MG16XU MG20XU

The new MG Series offers a comprehensive lineup of consoles suitable for a wide range of mixing environment. The versatile lineup includes variety of channel configurations, as well as models equipped with SPX effects processors and USB audio interface geared towards live performance and recording, perfect for any application from monitor mixes to seminars to front of house sound reinforcement in smaller venues.



Application

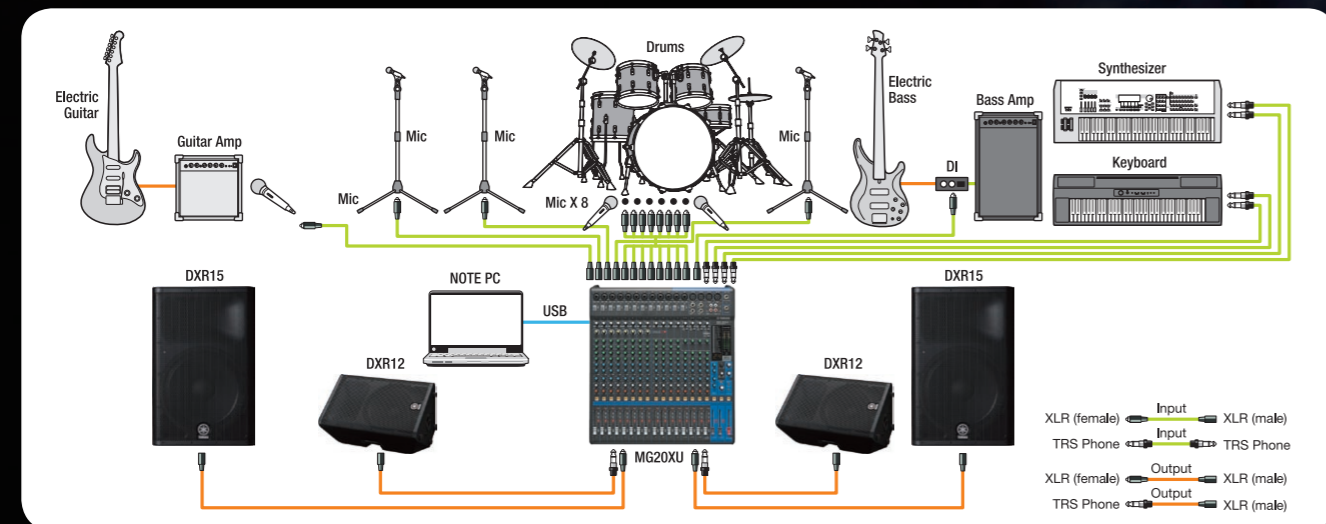

Application

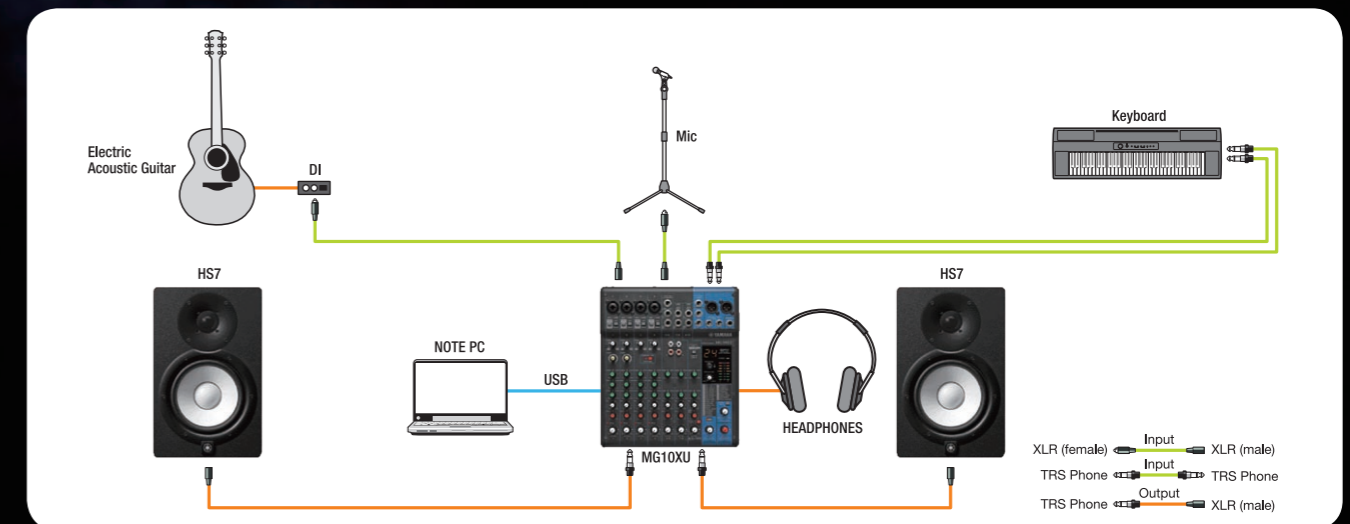

XU models

For a more precise control and enhancement of your sound, XU models of the MG Series come equipped with a suite of Yamaha's renowned SPX effects. Featuring high-resolution Chorus, Flanger, Distortions, Reverb and Delay, all with editable parameters, these are the same multi-effects processors used on Yamaha's high-end mixing consoles, giving you the tools you need to elevate your mixes to a higher plane.

MG10XU



MG12XU



MG16XU



MG20XU



10-Channel Mixing Console

- Max. 4 Mic / 10 Line Inputs (4 mono + 3 stereo)
- 1 Stereo Bus ● 1 AUX (incl. FX)
- "D-PRE" mic preamps with an inverted Darlington circuit
- 1-Knob compressors
- High-grade effects: SPX with 24 programs
- 24-bit / 192kHz 2in / 2out USB Audio functions
- Works with the iPad (2 or later) through the Apple iPad Camera Connection Kit / Lightning to USB Camera Adapter
- Includes Cubase AI DAW software download version
- PAD switch on mono inputs ● +48V phantom power
- XLR balanced outputs ● Metal chassis

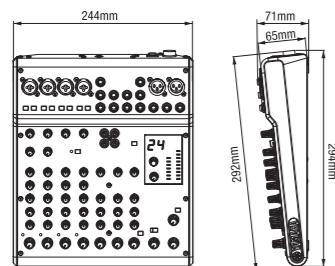

12-Channel Mixing Console

- Max. 6 Mic / 12 Line Inputs (4 mono + 4 stereo)
- 2 GROUP Buses + 1 Stereo Bus ● 2 AUX (incl. FX)
- "D-PRE" mic preamps with an inverted Darlington circuit
- 1-Knob compressors
- High-grade effects: SPX with 24 programs
- 24-bit / 192kHz 2in / 2out USB Audio functions
- Works with the iPad (2 or later) through the Apple iPad Camera Connection Kit / Lightning to USB Camera Adapter
- Includes Cubase AI DAW software download version
- PAD switch on mono inputs ● +48V phantom power
- XLR balanced outputs ● Internal universal power supply for world-wide use
- Optional Rack Mount Kit RK-MG12 Available ● Metal chassis

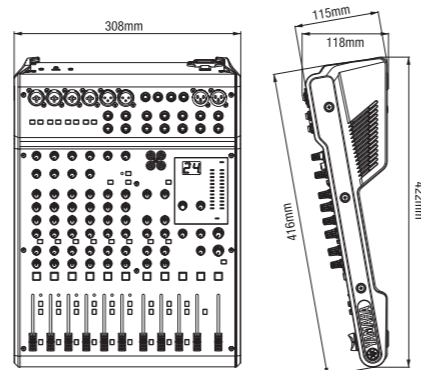

16-Channel Mixing Console

- Max. 10 Mic / 16 Line Inputs (8 mono + 4 stereo)
- 4 GROUP Buses + 1 Stereo Bus ● 4 AUX (incl. FX)
- "D-PRE" mic preamps with an inverted Darlington circuit
- 1-Knob compressors
- High-grade effects: SPX with 24 programs
- 24-bit/192kHz 2in/2out USB Audio functions
- Works with the iPad (2 or later) through the Apple iPad Camera Connection Kit / Lightning to USB Camera Adapter
- Includes Cubase AI DAW software download version
- PAD switch on mono inputs ● +48V phantom power
- XLR balanced outputs ● Internal universal power supply for world-wide use
- Rack Mount Kit Included ● Metal chassis

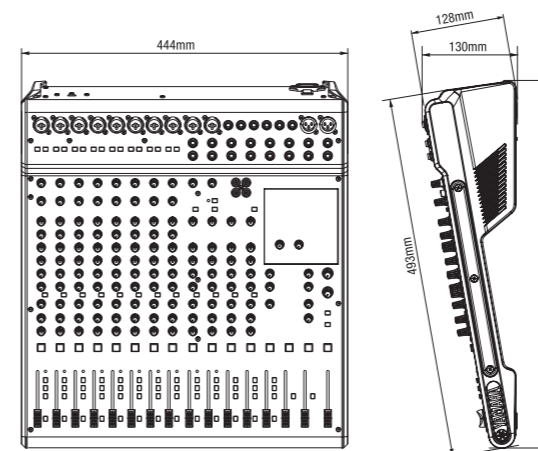

20-Channel Mixing Console

- Max. 16 Mic / 20 Line Inputs (12 mono + 4 stereo)
- 4 GROUP Buses + 1 Stereo Bus ● 4 AUX (incl. FX)
- "D-PRE" mic preamps with an inverted Darlington circuit
- 1-Knob compressors
- High-grade effects: SPX with 24 programs
- 24-bit/192kHz 2in/2out USB Audio functions
- Works with the iPad (2 or later) through the Apple iPad Camera Connection Kit / Lightning to USB Camera Adapter
- Includes Cubase AI DAW software download version
- PAD switch on mono inputs ● +48V phantom power
- XLR balanced outputs ● Internal universal power supply for world-wide use
- Rack Mount Kit Included ● Metal chassis

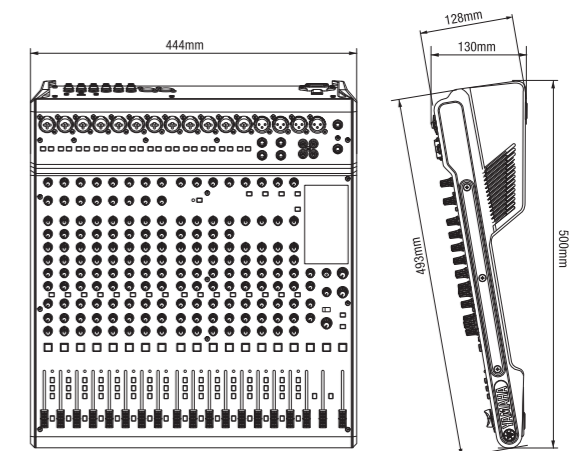

Standard Models

The third generation of the acclaimed MG Series, these compact mixing consoles focus on delivering high quality sound for a diverse range of mixing environments. With the same mic preamps as our high-end professional mixers, the MG Series provides serious sound with the reliability and performance this series is renowned for.

MG10



10-Channel Mixing Console

- Max. 4 Mic / 10 Line Inputs (4 mono + 3 stereo)
- 1 Stereo Bus ● 1 AUX (incl. FX)
- "D-PRE" mic preamps with an inverted Darlington circuit
- 1-Knob compressors ● PAD switch on mono inputs
- +48V phantom power ● XLR balanced outputs
- Metal chassis

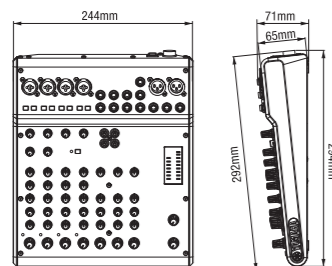

MG12



12-Channel Mixing Console

- Max. 6 Mic / 12 Line Inputs (4 mono + 4 stereo)
- 2 GROUP Buses + 1 Stereo Bus ● 2 AUX (incl. FX)
- "D-PRE" mic preamps with an inverted Darlington circuit
- 1-Knob compressors ● PAD switch on mono inputs
- +48V phantom power ● XLR balanced outputs
- Internal universal power supply for world-wide use
- Optional Rack Mount Kit RK-MG12 Available ● Metal chassis

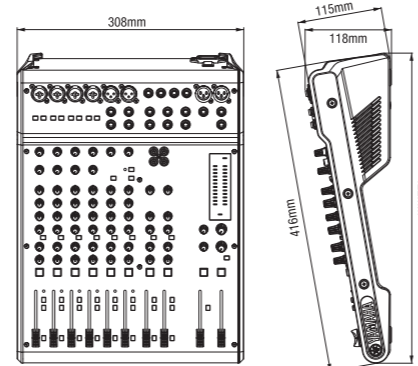

MG16



16-Channel Mixing Console

- Max. 10 Mic / 16 Line Inputs (8 mono + 4 stereo)
- 4 GROUP Buses + 1 Stereo Bus ● 4 AUX (incl. FX)
- "D-PRE" mic preamps with an inverted Darlington circuit
- 1-Knob compressors ● PAD switch on mono inputs
- +48V phantom power ● XLR balanced outputs
- Internal universal power supply for world-wide use
- Rack Mount Kit Included ● Metal chassis

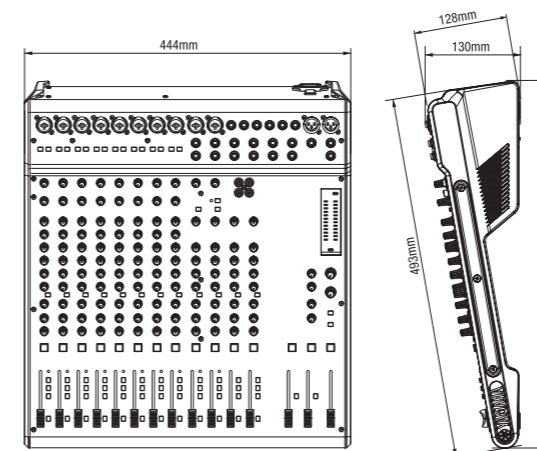

MG20



20-Channel Mixing Console

- Max. 16 Mic / 20 Line Inputs (12 mono + 4 stereo)
- 4 GROUP Buses + 1 Stereo Bus ● 4 AUX (incl. FX)
- "D-PRE" mic preamps with an inverted Darlington circuit
- 1-Knob compressors ● PAD switch on mono inputs
- +48V phantom power ● XLR balanced outputs
- Internal universal power supply for world-wide use
- Rack Mount Kit Included ● Metal chassis

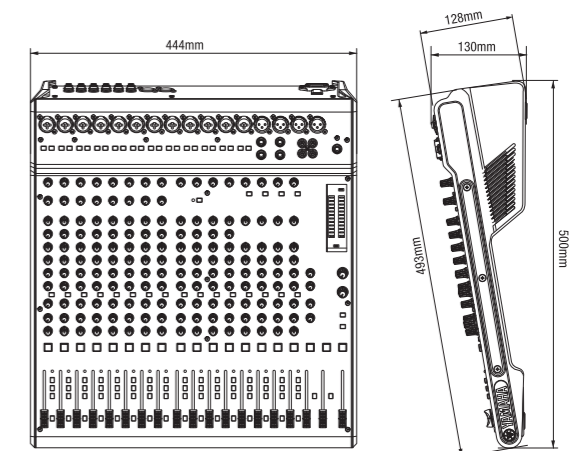

MG06 / MG06X



6-Channel Mixing Console

- Max. 2 Mic / 6 Line Inputs (2 mono + 2 stereo)
- 1 Stereo Bus
- "D-PRE" mic preamps with an inverted Darlington circuit
- XLR balanced outputs
- PAD switch on mono inputs
- +48V phantom power
- Metal chassis



6-Channel Mixing Console

- Max. 2 Mic / 6 Line Inputs (2 mono + 2 stereo)
- 1 Stereo Bus
- "D-PRE" mic preamps with an inverted Darlington circuit
- High-grade effects: SPX with 6 programs
- XLR balanced outputs
- PAD switch on mono inputs
- +48V phantom power
- Metal chassis

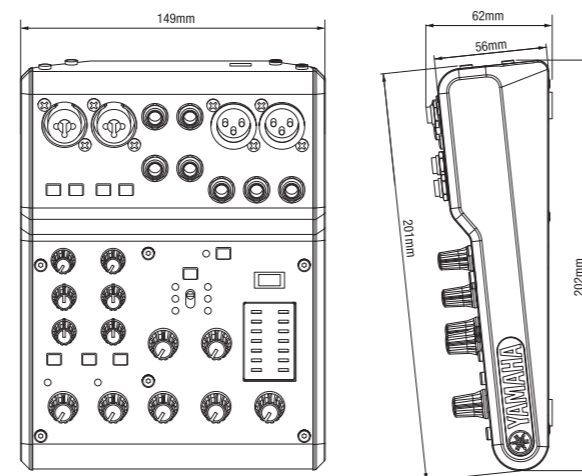
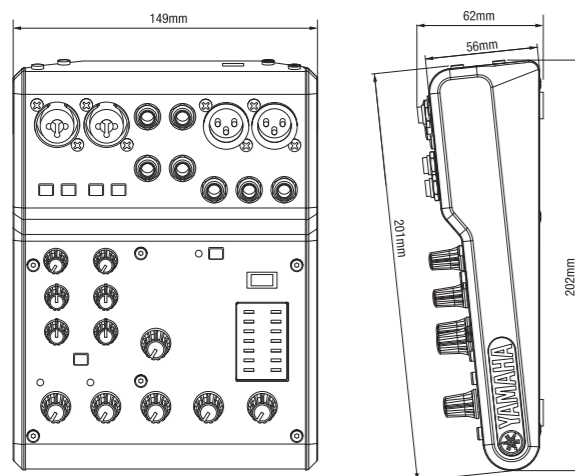

MG Series Specifications

General Specifications

		MG20XU / MG20	MG16XU / MG16	MG12XU / MG12
Frequency Response	Input to STEREO OUT	+0.5 dB/-1.5 dB (20 Hz to 48 kHz), refer to the nominal output level @ 1 kHz, GAIN knob: Min		
Total harmonic distortion (THD+N)	Input to STEREO OUT	0.03 % @ +14dBu (20 Hz to 20kHz), GAIN knob: Min 0.005 % @ +24dBu (1kHz), GAIN knob: Min		
Hum&Noise *1 (20 Hz to 20 kHz)	Equivalent Input Noise	-128 dBu (Mono Input Channel, Rs: 150Ω, GAIN knob: Max)		
	Residual Output Noise	-102 dBu (STEREO OUT, STEREO master fader: Min)		
Crosstalk(1 kHz) *2		-78 dB		
Input channels	Mono[MIC/LINE]	12	8	4
	Mono/Stereo[MIC/LINE]	4	2	2
	Stereo[LINE]	0	2	2
Output channels	STEREO OUT	2		
	MONITOR OUT	1		
	PHONES	1		
	AUX SEND	4	4	2
	GROUP OUT	4	4	2
Bus		Stereo: 1, GROUP: 4, AUX: 4 (MG20XU: incl. FX)	Stereo: 1, GROUP: 4, AUX: 4 (MG16XU: incl. FX)	Stereo: 1, GROUP: 2, AUX: 2 (MG12XU: incl. FX)
Input Channel Function	PAD (Mono)	26 dB		
	HPF (Mono, Mono/Stereo)	80 Hz, 12 dB/oct (Mono/Stereo: MIC only)		
	COMP (Mono)	1-knob compressor (Gain/Threshold/Ratio) Threshold: +22 dBu to -8 dBu, Ratio: 1:1 to 4:1, Output level: 0 dB to 7 dB Attack time: approx. 25 msec, Release time: approx. 300 msec		
	EQ	HIGH: Gain: +15 dB/-15 dB, Frequency: 10 kHz shelving		
		MID: Gain: +15 dB/-15 dB, Frequency: Mono 250 Hz – 5 kHz peaking Stereo 2.5 kHz peaking	MID: Gain: +15 dB/-15 dB, Frequency: 2.5 kHz peaking	
		LOW: Gain: +15 dB/-15 dB, Frequency: 100 Hz shelving		
	PEAK LED (Mono)	LED turns on when post EQ signal reaches 3 dB below clipping		
Level Meter	Pre Monitor LEVEL	2x12 -segment LED meter [PEAK, +10, +6, +3, 0, -3, -6, -10, -15, -20, -25, -30 dB]		
Internal Digital Effect (XU Models)	SPX algorithm	24 programs, PARAMETER control:1, FOOT SW:1 (FX RTN CH on/off)		
USB Audio (XU Models)	2 IN / 2 OUT	USB Audio Class 2.0 compliant Sampling Frequency: Max 192 kHz, Bit Depth: 24-bit		
Phantom Power Voltage		+48 V		
Power Requirements		AC 100 – 240 V, 50 / 60 Hz		
Power Consumption		36 W	30 W	22 W
Dimensions (W x H x D)		444 mm x 130 mm x 500 mm (17.5" x 5.1" x 19.7")	444 mm x 130 mm x 500 mm (17.5" x 5.1" x 19.7")	308 mm x 118 mm x 422 mm (9.6" x 2.8" x 11.6")
Net Weight		MG20XU:7.1kg (15.7 lbs.) MG20: 6.9kg (15.2 lbs.)	MG16XU:6.8 kg (15.0 lbs.) MG16: 6.6 kg (14.6 lbs.)	MG12XU:4.2 kg (9.3 lbs.) MG12:4.0 kg (8.8 lbs.)
Included Accessory		Owner's Manual, Technical Specifications, AC power cord, Cubase AI Download Information (XU Models) Rack-mount kit (MG20XU, MG20, MG16XU, MG16)		
Optional Accessory		Rack-mount kit: RK-MG12 (for MG12XU, MG12), Foot Switch: FC5 (XU Models)		
Operating Temperature		0 to +40°C		

0 dBu = 0.775 Vrms Output impedance of signal generator (Rs) = 150Ω

All level controls are nominal if not specified.

*1 Noise is measured with A-weighting filter. *2 Crosstalk is measured with 1 kHz band pass filter.

		MG10XU / MG10	MG06X / MG06
Frequency Response	Input to STEREO OUT	+0.5 dB/-1.0 dB (20 Hz to 48 kHz), refer to the nominal output level @ 1 kHz, GAIN knob: Min	+0.5 dB/-0.5 dB (20 Hz to 20 kHz), refer to the nominal output level @ 1 kHz, GAIN knob: Min
Total harmonic distortion (THD+N)	Input to STEREO OUT	0.02 % @ +14dBu (20 Hz to 20kHz), GAIN knob: Min 0.003 % @ +24dBu (1kHz), GAIN knob: Min	0.01 % @ +8dBu (20 Hz to 20kHz), GAIN knob: Min 0.003 % @ +18dBu (1kHz), GAIN knob: Min
Hum&Noise *1 (20 Hz to 20 kHz)	Equivalent Input Noise	-128 dBu (Mono Input Channel, Rs: 150Ω, GAIN knob: Max)	
	Residual Output Noise	-102 dBu (STEREO OUT, STEREO LEVEL knob: Min)	
Crosstalk(1 kHz) *2		-83 dB	-88 dB
Input channels		10 channels: Mono [MIC/LINE]: 4, Stereo[LINE]: 3	6 channels: Mono [MIC/LINE]: 2, Stereo[LINE]: 2
Output channels		STEREO OUT: 2, PHONES: 1, MONITOR OUT: 1, AUX[FX] SEND: 1	STEREO OUT: 2, PHONES: 1
Bus		Stereo: 1, AUX[FX], 1	Stereo: 1
Input Channel Function	PAD (Mono)	26 dB	26 dB
	HPF (Mono)	80 Hz, 12 dB/oct	80 Hz, 12 dB/oct
	COMP	1-knob compressor Threshold: +22 dBu to -8 dBu, Ratio: 1:1 to 4:1, Output level: 0 dB to 7 dB Attack time: approx. 25 msec, Release time: approx. 300 msec	—
	EQ HIGH	Gain: +15 dB/-15 dB, Frequency: 10 kHz shelving	(Mono) Gain: +15 dB/-15 dB, Frequency: 10 kHz shelving
	EQ MID	Gain: +15 dB/-15 dB, Frequency: 2.5kHz peaking	—
	EQ LOW	Gain: +15 dB/-15 dB, Frequency: 100 Hz shelving	(Mono) Gain: +15 dB/-15 dB, Frequency: 100 Hz shelving
	PEAK LED (Mono)	LED turns on when post EQ signal reaches 3 dB below clipping	LED turns on when post EQ signal reaches 3 dB below clipping
Level Meter	Post STEREO LEVEL knob	2 x 7 -segment LED meter [PEAK, +10, +6, 0, -6, -10, -20 dB]	2 x 7 -segment LED meter [PEAK, +6, +3, 0, -3, -10, -20 dB]
Internal Digital Effect	SPX algorithm	24 programs (MG10XU)	6 programs (MG06X)
USB Audio (MG10XU)	2 IN / 2 OUT	USB Audio Class 2.0 compliant Sampling Frequency: Max 192 kHz, Bit Depth: 24-bit (MG10XU)	—
Phantom Power Voltage		+48 V	+48 V
Power Supply adaptor		PA-10 (AC 38 VCT, 0.62A, Cable length = 3.6 m) or equivalent recommended by Yamaha	PA-130 (DC12 V/1.0 A, Cable length = 1.8 m), 120 V, 60 Hz MU18 (DC12 V/1.5 A, Cable length = 1.5 m), 100 V-240 V, 50 Hz/60 Hz or equivalent recommended by Yamaha
Power Consumption		22.9 W	12 W
Dimensions (W×H×D)		244 mm x 71 mm x 294 mm (9.6" x 2.8" x 11.6")	149 mm x 62 mm x 202 mm (5.9" x 2.4" x 7.9")
Net Weight		MG10XU: 2.1 kg (4.63 lbs.), MG10: 1.9 kg (4.19 lbs.)	MG06X: 0.9 kg (1.98 lbs.), MG06: 0.9 kg (1.98 lbs.)
Included Accessory		AC Adaptor, Owner's Manual, Cubase AI Download Information (MG10XU), Technical Specifications	AC Adaptor, Owner's Manual, Technical Specifications
Optional Accessory		Mic Stand Adaptor: BMS-10A, Foot Switch: FC5 (MG10XU)	
Operating Temperature		0 to +40°C	

0 dBu = 0.775 Vrms Output impedance of signal generator (Rs) = 150Ω

All level knobs are nominal if not specified.

*1 Noise is measured with A-weighting filter. *2 Crosstalk is measured with 1 kHz band pass filter.

MG20 / MG20XU Analog Input Characteristics

Input Jacks	PAD 26 dB	GAIN Trim Position	Actual Load Impedance	For Use With Nominal	Input level			Connector
					Sensitivity *1	Nominal	Max. before clip	
MIC/LINE 1-12	OFF	+64 dB	3kΩ	50-600Ω Mics/Lines	-80 dBu (0.077 mV)	-60 dBu (0.775 mV)	-40 dBu (7.75 mV)	Combo jack *2 (Balanced)
		+20 dB			-36 dBu (12.3 mV)	-16 dBu (122.8 mV)	+4 dBu (1.228 V)	
	ON	+38 dB			-54 dBu (1.55 mV)	-34 dBu (15.46 mV)	-14 dBu (154.6 mV)	
		-6 dB			-10 dBu (245 mV)	+10 dBu (2.451 V)	+30 dBu (24.51 V)	
MIC 13/14-19/20	-	+64 dB	3kΩ	50-600Ω Mic	-80 dBu (0.077 mV)	-60 dBu (0.775 mV)	-40 dBu (7.75 mV)	XLR-3-31 *3 (Balanced)
		+20 dB			-36 dBu (12.3 mV)	-16 dBu (122.8 mV)	+4 dBu (1.228 V)	
LINE 13/14-15/16	-	+38 dB	10kΩ	600Ω Lines	-54 dBu (1.55 mV)	-34 dBu (15.46 mV)	-14 dBu (154.6 mV)	Phone jack *5 (Unbalanced)
		-6 dB			-10 dBu (245 mV)	+10 dBu (2.451 V)	+30 dBu (24.51 V)	
LINE 17/18-19/20	-	+38 dB	10kΩ	600Ω Lines	-54 dBu (1.55 mV)	-34 dBu (15.46 mV)	-14 dBu (154.6 mV)	RCA Pin (Unbalanced)
		-6 dB			-10 dBu (245 mV)	+10 dBu (2.451 V)	+30 dBu (24.51 V)	

MG20 / MG20XU Analog Output Characteristics

Output Terminals	Actual Source Impedance	For Use With Nominal	Output level		Connector
			Nominal	Max. before clip	
STEREO OUT [L, R]	75Ω	600Ω Lines	+4 dBu (1.228 V)	+24 dBu (12.28 V)	XLR-3-32 *3 Phone jack *4 (Balanced)
MONITOR OUT [L, R] GROUP OUT [1-4] AUX SEND [1-4]	150Ω	10kΩ Lines	+4 dBu (1.228 V)	+20 dBu (7.750 V)	Phone jack *4 (Impedance Balanced)
PHONES	110Ω	40Ω Phones	3 mW + 3 mW	100 mW + 100 mW	Stereo phone jack

MG16 / MG16XU Analog Input Characteristics

Input Jacks	PAD 26 dB	GAIN Trim Position	Actual Load Impedance	For Use With Nominal	Input level			Connector
					Sensitivity *1	Nominal	Max. before clip	
MIC/LINE 1-8	OFF	+64 dB	3kΩ	50-600Ω Mics/Lines	-80 dBu (0.077 mV)	-60 dBu (0.775 mV)	-40 dBu (7.75 mV)	Combo jack *2 (Balanced)
		+20 dB			-36 dBu (12.3 mV)	-16 dBu (122.8 mV)	+4 dBu (1.228 V)	
	ON	+38 dB			-54 dBu (1.55 mV)	-34 dBu (15.46 mV)	-14 dBu (154.6 mV)	
		-6 dB			-10 dBu (245 mV)	+10 dBu (2.451 V)	+30 dBu (24.51 V)	
MIC 9/10, 11/12	-	+64 dB	3kΩ	50-600Ω Mic	-80 dBu (0.077 mV)	-60 dBu (0.775 mV)	-40 dBu (7.75 mV)	XLR-3-31 *3 (Balanced)
		+20 dB			-36 dBu (12.3 mV)	-16 dBu (122.8 mV)	+4 dBu (1.228 V)	
LINE 9/10, 11/12	-	+38 dB	10kΩ	600Ω Lines	-54 dBu (1.55 mV)	-34 dBu (15.46 mV)	-14 dBu (154.6 mV)	Phone jack *5 (Unbalanced)
		-6 dB			-10 dBu (245 mV)	+10 dBu (2.451 V)	+30 dBu (24.51 V)	
LINE 13/14-15/16	-	+38 dB	10kΩ	600Ω Lines	-54 dBu (1.55 mV)	-34 dBu (15.46 mV)	-14 dBu (154.6 mV)	Phone jack *5 (Unbalanced)
		-6 dB			-10 dBu (245 mV)	+10 dBu (2.451 V)	+30 dBu (24.51 V)	

MG16 / MG16XU Analog Output Characteristics

Output Terminals	Actual Source Impedance	For Use With Nominal	Output level		Connector
			Nominal	Max. before clip	
STEREO OUT [L, R]	75Ω	600Ω Lines	+4 dBu (1.228 V)	+24 dBu (12.28 V)	XLR-3-32 *3 Phone jack *5 (Balanced)
MONITOR OUT [L, R] GROUP OUT [1-4] AUX SEND [1-4]	150Ω	10kΩ Lines	+4 dBu (1.228 V)	+20 dBu (7.750 V)	Phone jack *4 (Impedance Balanced)
PHONES	110Ω	40Ω Phones	3 mW + 3 mW	100 mW + 100 mW	Stereo phone jack

Digital Input / Output Characteristics (XU Models)

Output Terminals	Format	Data Length	Fs	Connector
USB	USB Audio Class 2.0	16 / 24bit	44.1 kHz, 48 kHz, 88.2 kHz, 96 kHz, 176.4kHz, 192 kHz	USB Standard-B

0dBu is referenced to 0.775Vrms.

*1 Sensitivity is the lowest level that will produce an output of +4dBu (1.228V) or the nominal output level when the unit is set to maximum gain. (All level controls are maximum position.)

*2 1&Sleeve = GND, 2&Tip = HOT, 3&Ring = COLD

*3 1 = GND, 2 = HOT, 3 = COLD

*4 Tip = HOT, Ring = COLD, Sleeve = GND

*5 Tip = Signal, Sleeve = GND

MG12 / MG12XU Analog Input Characteristics

Input Jacks	PAD 26 dB	GAIN Trim Position	Actual Load Impedance	For Use With Nominal	Input level			Connector
					Sensitivity *1	Nominal	Max. before clip	
MIC/LINE 1-4	OFF	+64 dB	3kΩ	50-600Ω Mics/Lines	-80 dBu (0.077 mV)	-60 dBu (0.775 mV)	-40 dBu (7.75 mV)	Combo jack *2 (Balanced)
		+20 dB			-36 dBu (12.3 mV)	-16 dBu (122.8 mV)	+4 dBu (1.228 V)	
	ON	+38 dB			-54 dBu (1.55 mV)	-34 dBu (15.46 mV)	-14 dBu (154.6 mV)	
		-6 dB			-10 dBu (245 mV)	+10 dBu (2.451 V)	+30 dBu (24.51 V)	
MIC 5/6, 7/8	-	+64 dB	3kΩ	50-600Ω Mic	-80 dBu (0.077 mV)	-60 dBu (0.775 mV)	-40 dBu (7.75 mV)	XLR-3-31 *3 (Balanced)
		+20 dB			-36 dBu (12.3 mV)	-16 dBu (122.8 mV)	+4 dBu (1.228 V)	
LINE 5/6, 7/8	-	+38 dB	10kΩ	600Ω Lines	-54 dBu (1.55 mV)	-34 dBu (15.46 mV)	-14 dBu (154.6 mV)	Phone jack *5 (Unbalanced)
		-6 dB			-10 dBu (245 mV)	+10 dBu (2.451 V)	+30 dBu (24.51 V)	
LINE 9/10	-	+38 dB	10kΩ	600Ω Lines	-54 dBu (1.55 mV)	-34 dBu (15.46 mV)	-14 dBu (154.6 mV)	Phone jack *5 (Unbalanced)
		-6 dB			-10 dBu (245 mV)	+10 dBu (2.451 V)	+30 dBu (24.51 V)	

MG12 / MG12XU Analog Output Characteristics

Output Terminals	Actual Source Impedance	For Use With Nominal	Output level		Connector
			Nominal	Max. before clip	
STEREO OUT [L, R]	75Ω	600Ω Lines	+4 dBu (1.228 V)	+24 dBu (12.28 V)	XLR-3-32 *3 Phone jack *4 (Balanced)
MONITOR OUT [L, R] GROUP OUT [1, 2] AUX SEND [1, 2]	150Ω	10kΩ Lines	+4 dBu (1.228 V)	+20 dBu (7.750 V)	Phone jack *4 (Impedance Balanced)
PHONES	110Ω	40Ω Phones	3 mW + 3 mW	100 mW + 100 mW	Stereo phone jack

MG10 / MG10XU Analog Input Characteristics

Input Jacks	PAD 26 dB	GAIN Trim Position	Actual Load Impedance	For Use With Nominal	Input level			Connector
					Sensitivity *1	Nominal	Max. before clip	
MIC/LINE 1-4	OFF	+64 dB	3kΩ	50-600Ω Mics/Lines	-72 dBu (0.195 mV)	-60 dBu (0.775 mV)	-40 dBu (7.75 mV)	Combo jack *2 (Balanced)
		+20 dB			-28 dBu (30.9 mV)	-16 dBu (122.8 mV)	+4 dBu (1.228 V)	
	ON	+38 dB			-46 dBu (3.884 mV)	-34 dBu (15.46 mV)	-14 dBu (154.6 mV)	
		-6 dB			-2 dBu (615.6 mV)	+10 dBu (2.451 V)	+30 dBu (24.51 V)	
LINE 5/6, 7/8	-	+38 dB	10kΩ	600Ω Lines	-22 dBu (615.6 mV)	-10 dBu (245.1 mV)	+10 dBu (2.451 V)	Phone jack *5 (Unbalanced)
		-6 dB			-22 dBu (615.6 mV)	-10 dBu (245.1 mV)	+10 dBu (2.451 V)	

MG10 / MG10XU Analog Output Characteristics

Output Terminals	Actual Source Impedance	For Use With Nominal	Output level		Connector
			Nominal	Max. before clip	
STEREO OUT [L, R]	75Ω	600Ω Lines +20 dB	+4 dBu (1.228 V)	+24 dBu (12.28 V)	XLR-3-32 *3 Phone jack *5 (Balanced)
MONITOR OUT [L, R] AUX[FX] SEND	150Ω	10kΩ Lines	+4 dBu (1.228 V)	+20 dBu (7.750 V)	Phone jack *4 (Impedance Balanced)
PHONES	110Ω	40Ω Phones	3 mW + 3 mW	100 mW + 100 mW	Stereo phone jack

MG06 / MG06X Analog Input Characteristics

Input Jacks	PAD 26 dB	GAIN Trim Position	Actual Load Impedance	For Use With Nominal	Input level			Connector
					Sensitivity *1	Nominal	Max. before clip	
MIC/LINE 1/L, 2/R	OFF	+64 dB	3kΩ	50-600Ω Mics/Lines	-72 dBu (0.195 mV)	-60 dBu (0.775 mV)	-46 dBu (3.884 mV)	Combo jack *2 (Balanced)
		+20 dB			-28 dBu (30.9 mV)	-16 dBu (122.8 mV)	-2 dBu (615.6 mV)	
	ON	+38 dB			-46 dBu (3.884 mV)	-34 dBu (15.46 mV)	-20 dBu (77.5 mV)	
		-6 dB			-2 dBu (615.6 mV)	+10 dBu (2.451 V)	+24 dBu (12.283 V)	
LINE 3/4, 5/6	-	+38 dB	10kΩ	600Ω Lines	-22 dBu (615.6 mV)	-10 dBu (245.1 mV)	+4 dBu (1.228 V)	Phone jack *5 (Unbalanced)
		-6 dB			-22 dBu (615.6 mV)	-10 dBu (245.1 mV)	+4 dBu (1.228 V)	

MG06 / MG06X Analog Output Characteristics

Output Terminals	Actual Source Impedance	For Use With Nominal	Output level		Connector
			Nominal	Max. before clip	
STEREO OUT [L, R]	75Ω	10kΩ Lines	+4 dBu (1.228 V)	+18 dBu (6.156 V)	XLR-3-32 *3 Phone jack *4 (Balanced)
PHONES	33Ω	40Ω Phones	2.4 mW + 2.4 mW	24 mW + 24 mW	Stereo phone jack

Channel Strip (MG20XU)



Mono Input Channel

Stereo Input Channel

Stereo / USB Input Channel

Master & Effects Section

